



CASA R3 Smart

Air handling unit with the market's lowest sound level



Swegon CASA R3 Smart

Spice rack air handling unit with rotary heat exchanger (599 x 366 x 700 mm, Ø125 mm) suitable for kitchen or bathroom installation in smaller homes (288m³/h, 150 m²). Equipped with a fifth duct connection for an externally placed cooker hood. The market's most intelligent demand-controlled humidity function as standard. Developed, manufactured and tested for Nordic climate.

Free energy with rotary heat exchanger

The heat exchanger makes use of the energy in the indoor air in the winter to heat the incoming outdoor air and in the summer to reduce the supply air temperature.

On a cold winter day the heat exchanger gives "free" heating energy up to 36°C by converting the -20° cold outdoor air to +16°C warm supply air. The heat exchanger is manufactured with aluminium fins and provides a high degree of efficiency. A certain amount of moisture, removed with the extract air, is recovered to the supply air. This is especially beneficial in the winter when the outdoor air is usually dry, which results in problems for people and the interior.

Defrosting

The defrosting function guarantees continuous ventilation in the home even during cold conditions. If there is a risk of the unit's heat exchanger freezing, the speed of the fans increases and the warm extract air prevents freezing occurring inside the heat exchanger. With the help of a preheater (accessory), you can maintain balanced ventilation and avoid negative pressure in the residence even under extreme conditions.

Preheater

With the help of a preheater (accessory), you can maintain balanced ventilation and avoid negative pressure in the residence even under extreme conditions and enable balancing functions for fireplaces and cooker hoods.

Reheater

Usually the recovered thermal energy from the extract air is sufficient to heat the supply air. In cold conditions, an electric or waterborne reheater can be used to maintain a comfortable indoor climate. It can be placed internally in the air handling unit or externally in the duct (see technical data).

Automatic summer mode

Summer mode helps to maintain the home's indoor air comfort. The heat exchanger makes use of the cool indoor air during warm days and cools the incoming outdoor air. At night the home is cooled with fresh outdoor air. This is managed by an advanced automatic

system that can be set according to the resident's requirements. Very economical comfort coolness can be produced intelligently almost free of charge.

Cooling

If there is access to cold water in the property (e.g. cooling pump), a cooling coil can be installed in the supply air/outdoor air duct to produce comfort cooling in the residence. The supply air temperature is controlled automatically from the ventilation unit's control system.

Separate connection for a cooker hood

The cooker hood can be connected via a separate duct to the unit. The cooker hood does not need a separate fan, duct, roof duct or roof hood. Permits balancing function for the cooker hood.

Installation

The unit can either be mounted on a wall or suspended from the ceiling using a separate ceiling mounting frame. R3 is also suitable for mounting on the wall above the cooker hood in place of a spice rack. Swegon CASA Jazz cooker hood is connected directly to the unit. R3 Flat model can be installed with a furniture door mounted in front of the device to create gives uniform look for the kitchen cabinets. The door can be mounted with magnet holders that are available as an accessory (TB00316).

- 1 Ecodesign energy class A*
- 2 Air flow range 90-288 m³/h
- 3 Temperature efficiency up to 86 % (EN 308)
- 4 Annual efficiency up to 80 % (Stockholm 21°C)
- 5 Demand-controlled humidity function as standard
- 6 Automatic summer function and passive cooling
- 7 Anti-frost protection ensures continuous ventilation
- 8 External coils for heating and cooling as an option
- 9 Can be connect to the automated building management system (I/O/Modbus)
- 10 Can be wall mounted above the cooker hood in place of a spice rack.

*Energy classification according to EcoDesign directive Lot 6. Energy class may vary depending on the selected accessories.

R3 Flat with furniture door mounted in front of the unit



Smart control technology

Controls (options)

CASA Smart ventilation units are equipped with the market's most versatile control options! Select the required control method or combine several!



Smart Access

Use your mobile device to control and monitor your indoor climate. Connect the Smart Access module to your ventilation unit and connect it to your home network.



Smart control panel

White wall mounted control panel with a colour display and touch buttons for both recessed and surface mounted installation.



Cooker hood

All Smart cooker hoods can be used to regulate the ventilation unit in three modes (home, away, boost). Automatically balances the ventilation when a cooker hood is used.



Building automation

Centralised monitoring and control with the help of Modbus connection modules or configurable I/O.

Basic functions

You can switch as required to an appropriate operating mode or let the pre-programmed weekly clock switch operating mode according to the diurnal rhythm you want.



Boosted air flow

A large air flow is used when the ventilation requirement increases, e.g. for cooking, taking a sauna, showering or drying laundry.



Home

Normal air flow. Guarantees that there is sufficient fresh indoor air in the home, and that the building construction is at its best.



Away

Low air flow. Reduces energy consumption when the ventilation requirement in the home is small.



Travelling

Very low air flow and lower supply air temperature. Used when no one is present in the home.

Compensation functions

Compensates ventilation flows in the home in order to facilitate for the inhabitants.



Fireplace function

An intelligent fireplace function that helps to produce the correct amount of replacement air, specifically for your fireplace. Facilitates lighting the fire and ensures clean combustion.



Cooker hood function

Balances the ventilation when a cooker hood is used. Helps to prevent excessive negative pressure and improves fume extraction capability of the cooker hood.



Central vacuum cleaner function

Balances the ventilation when a central vacuum cleaner is used. Helps to prevent excessive negative pressure and improves the cleaning result.

Automatic functions (options)

Intelligent ventilation is capable of identifying residents' needs. The Smart System measures the indoor air quality and knows exactly how much ventilation is required in different situations.



Intelligent humidity automation (RH) as standard

The market's most advanced moisture automation is now standard in all new Swegon CASA ventilation units. While traditional humidity sensors only switch the ventilation to boosted ventilation, the Smart Automation continuously analyses the indoor air and regulates the ventilation in accordance with the actual humidity variations.



Automatic Home/Away/Boost system (CO₂)

automatically lowers the ventilation to Away mode and saves energy when the home is empty. When the residents are at home, the ventilation is automatically increased to bring exactly the right amount of fresh air into the home.



Air Quality Automation (VOC)

increases the ventilation if too much pollution is detected in the indoor air, such as odours or vapours (evaporating organic compounds).

The Smart Control is easy to activate. The installation does not require cabling around the home, and can also be installed retrospectively in older Smart ventilation units.

R3 with stainless cover plated installed in front of the unit



Technical data



	R3	R3 + reheating
Air flow range (according to Ecodesign)	90-288 m ³ /h	90-288 m ³ /h
Rated voltage	230 V, 50 Hz, 1,0 A	230 V, 50 Hz, 3,2 A
Fans	230 W	230 W
Internal electric preheater	—	—
Internal electric reheater	—	500 W
External electric pre/reheater (Duct mounted)	As an option	As an option
External water based heating coil/cooling coil (Duct mounted)	As an option	As an option
Max. total output	250 W	750 W
Max. total output with Jazz cooker hood	265 W	765 W
Fuse protection	10 A	10 A
Weight	50 kg	50 kg
Duct connections	Ø 125 mm	Ø 125 mm
Outlet for condensate	—	—

Dimensions, w x l x h	599 x 366 x 700 mm
Heat exchangers	Rotary heat exchanger.
Enclosure class	IP34
Control system	CASA Smart + automatic humidity function as standard
Control panel CASA Smart	Available as an option
Filters	Filter class ISO ePM1 55% (F7) for supply air and extract air
Colour, exterior	White, RAL 9016 (corresponds to NCS S1002-G50Y)

ENERG
енергия · ενεργεια

Y
IJA
IE
IA

Swegon CASA R03VR05S00H

39
dB

295 m³/h

ENERGIA · ЕНЕРГИЯ · ΕΝΕΡΓΕΙΑ · ENERGIJA · ENERGY · ENERGIE · ENERGI
2016 **1254/2014**





(SEC) in kWh

Cold climate	-82.4	A+
Mean climate	-39.5	A
Warm climate	-14.9	E

The energy class may vary depending on how the unit is equipped.



Dimensions

 Outdoor air
  Supply air
  Extract air
  Exhaust air

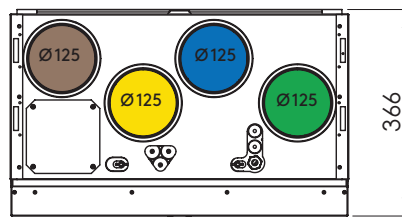
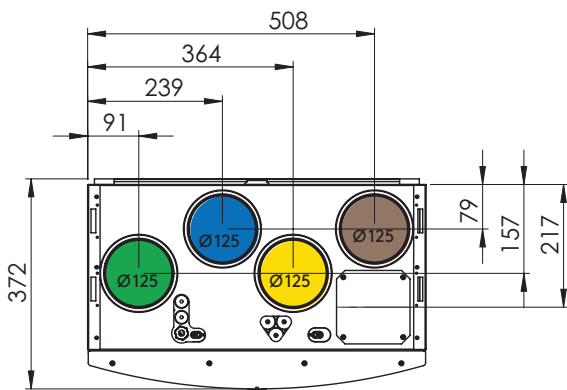
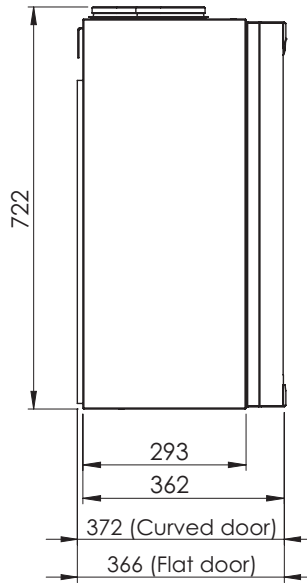
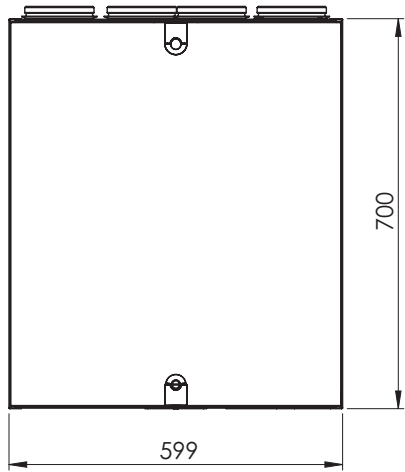

CASA R3 R, right-hand version

CASA R3 L Flat, left-hand version

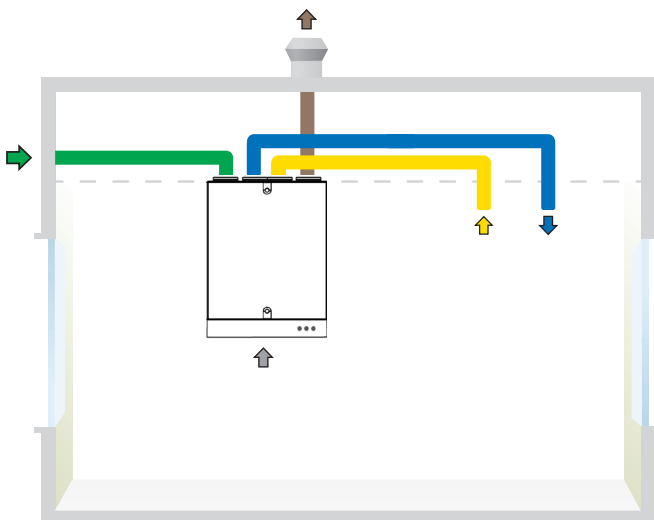

CASA R3 R, duct connections and cooker hood connected to the bottom of the ventilation unit.

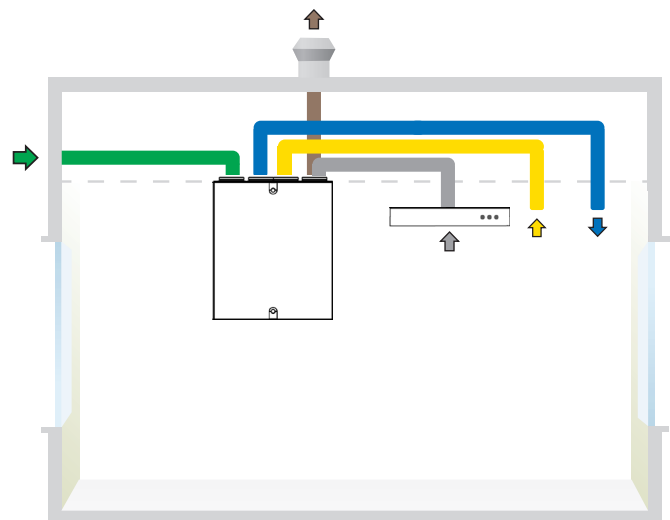

CASA R3 R, duct connections and cooker hood connected to the kitchen duct connection on top the ventilation unit.

Note! Always check the unit design (L/R) and correct duct sequence in the installation instructions.

Fan curves

More detailed data for sound to the surroundings and duct connections are available via procasa.swegon.com.

Sound power level emitted to the supply air duct

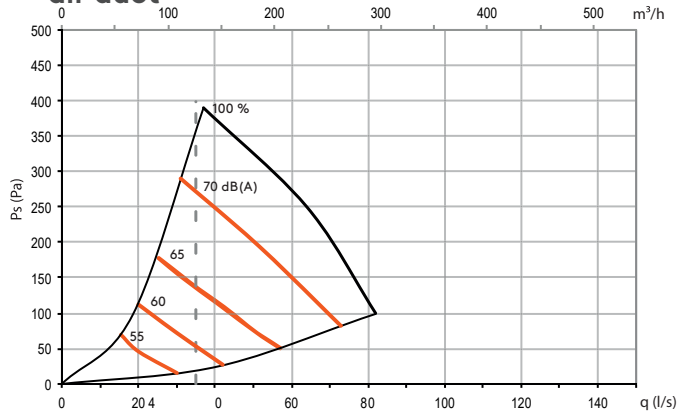

Sound power level emitted to the extract air duct

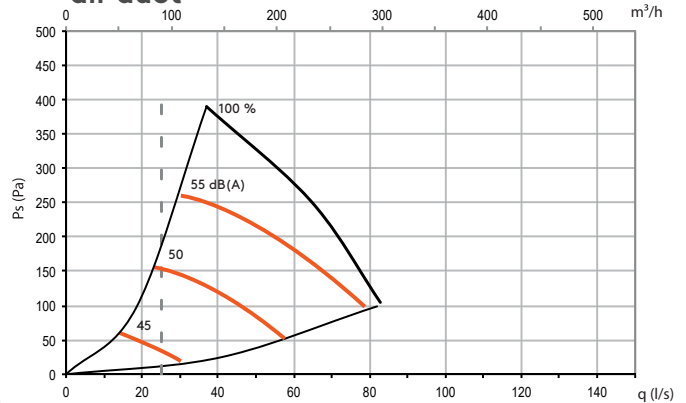

Sound power level emitted to the exhaust air duct

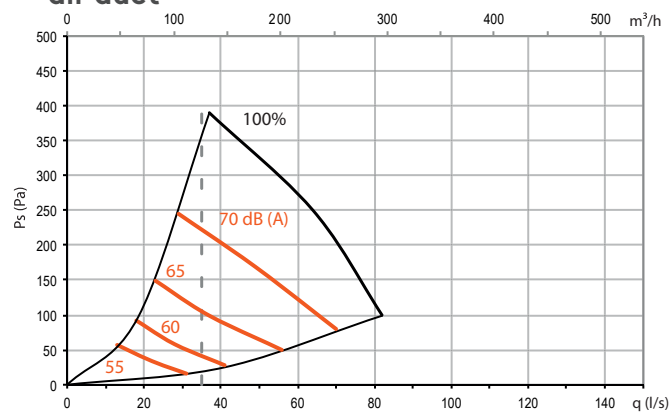

Sound power level to a duct for outdoor air

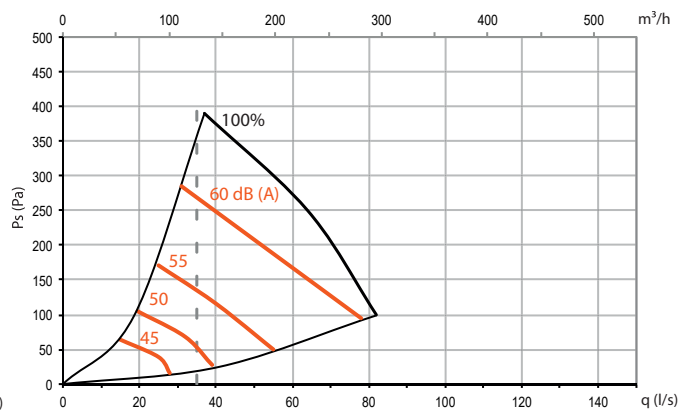

Sound power level to a duct for kitchen bypass

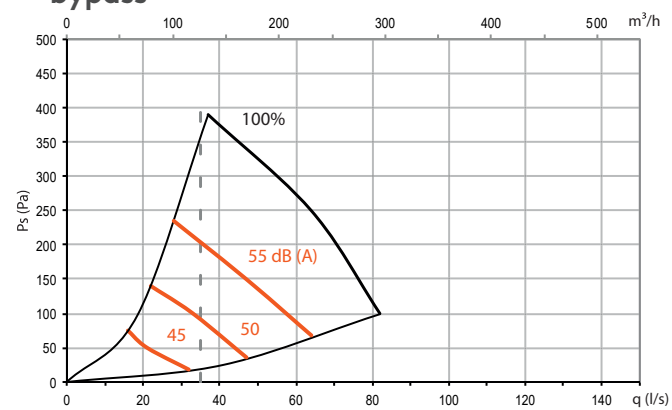

Air flow and sound power level to the surroundings

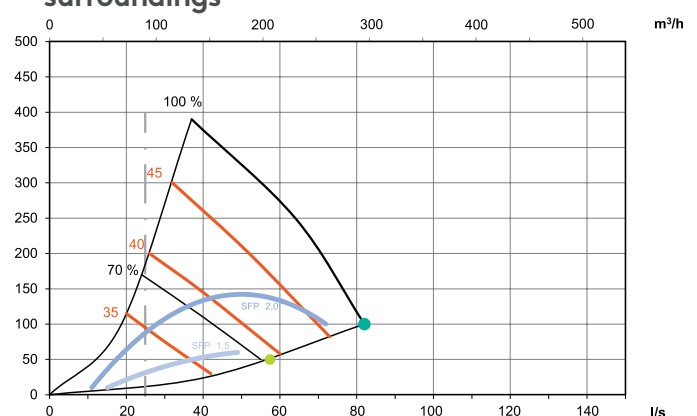

	Sound power level L_w (dB), table K_{OK}							
	63 Hz	125 Hz	250 Hz	500 Hz	1000 Hz	2000 Hz	4000 Hz	8000 Hz
Sound emitted to supply air duct	12	9	1	-1	-9	-13	-20	-28
Sound emitted to extract air duct	12	11	2	-3	-9	-17	-24	-32
Sound emitted to exhaust air duct	12	8	3	-1	-10	-15	-22	-29
Sound to a duct for outdoor air	15	11	4	-4	-19	-28	-40	-52
Sound emitted to a duct for kitchen bypass	15	13	4	-7	-19	-32	-41	-53
Sound emitted to the surroundings	9	-1	1	-2	-3	-17	-21	-27

Correction table for sound pressure level		
room area	normally furnished room	heavily furnished room
5 m ²	- 2 dB(A)	+ 3 dB(A)
10 m ²	- 4 dB(A)	0 dB(A)
15 m ²	- 5 dB(A)	- 3 dB(A)

More detailed sound data according to set values is available in ProCASA.

Air handling unit and accessories



CASA R3 Smart

- 90-288 m³/h, 4 x Ø125 mm + Ø100 mm
- Supplied with approx. 1.5 m controlled cable. Order control panel and 10 m/20 m extension cable separately.
- Humidity automation as standard (RH)
- Wall mounting bracket

Part no.	Energy class*	Description
R03VR05S00H	A+ / A / E	CASA R3 Smart R 500W RH
R03VL05S00H	A+ / A / E	CASA R3 Smart L 500W RH
R03VR00S00H	A+ / A / E	CASA R3 Smart R RH
R03VL00S00H	A+ / A / E	CASA R3 Smart L RH



R03VR00S00HF	A+ / A / E	CASA R3 Smart R RH Flat door
R03VL00S00HF	A+ / A / E	CASA R3 Smart L RH Flat door
R03VR05S00HF	A+ / A / E	CASA R3 Smart R 500 W RH Flat door
R03VL05S00HF	A+ / A / E	CASA R3 Smart L 500 W RH Flat door

L = exhaust air left. *Energy classification according to EcoDesign directive Lot 6 (Cold/**Medium**/Warm).

Part no.	Description
TB00316	Magnet holders (4 pcs) for mounting furniture door (only with Flat door model)



Filter

PR085FS	2 x spare filter ISO ePM1 55% (F7)
---------	------------------------------------

Cooker hood

CASA R3 can be installed integrated cooker hood for placement above the cooker.

Jazz:

- Motorised damper, touch panel
- LED lighting, 6x spotlight
- White or stainless steel with glass front



PJV6R	Cooker hood Jazz, white, right
PJV6L	Cooker hood Jazz, white, left
PJR6R	Cooker hood Jazz, stainless steel, right
PJR6L	Cooker hood Jazz, stainless steel, left

Cover plate for the front panel

Choose cover plate for the CASA R3 Smart to match the look of the cooker hood. Available as a complement to the standard panel – just replace the cover plate. Fits both right-hand and left-hand units.



PR085B6R	Cover plate, stainless steel (Do not use with the Flat door model)
----------	--

Control accessories

White wall mounted control panel with a colour display and touch buttons for both recessed and surface mounted installation.



SC10	Control panel (1-2 per unit)
SC14	SC10 + modular cable 10 m
SC15	SC10 + modular cable 10 m + mounting frame
SC16	SC10 + mounting frame
102SAK	Mounting frame, for surface mounting of the control panel
PMK20	Modular cable, 20 m and RJ9 adapter for units
604010	Modular cable 10m



Control accessories

Use your mobile device to control and monitor your indoor climate. Connect the Smart Access module to your ventilation unit and connect it to your home network.



SMA	Smart Access module for connection to the internet
SMAW	Smart Access module + WLAN router
SMAG	Smart Access module + 3G/4G mobile router (not SIM)

Building automation

As standard the ventilation unit has two configurable I/O channels. If there is a need of additional connection points, the ventilation unit has space for a separate connection cable (SEC). Modbus connection module (SEM) gives you advanced connection options to a master system.



SEM	Modbus connection module
SEC	Connection cable (configurable I/O) for Smart ventilation units
WSTC	Room temperature sensor, total package with connection unit for ventilation units. The sensor is installed on the wall or in a recessed junction box (60 mm between holes).

Automatic functions

With the help of an internally mounted sensor, it is easy to fully automate your apartment's ventilation system. Can easily be retro-fitted by replacing the existing internal RH-sensor.



SRHCO2	Automatic Home/Away/Boost system + humidity automation (RH + CO2)
SRHVO	Automatic air quality system + humidity automation (RH+VOC)

Waterborne air coolers

With an air cooler mounted in the supply air duct, comfort cooling is created in the residence by connecting a cooling medium circuit or a cooling water circuit to the cooler. The air cooler is controlled automatically from the ventilation unit's Smart control system and settings can be changed using a CASA Smart control panel. The delivery includes: Air cooler, SET connection module, actuator and 3-way valve, 24 V transformer, requisite sensors and instructions.



SDCW160	Cooling coil pack Ø160
SDCW200	Cooling coil pack Ø200

Waterborne air heaters

In buildings equipped with a waterborne heating system, the supply air can be heated with a duct mounted waterborne air heater. The air heater is controlled automatically from the ventilation unit's Smart control system and settings can be changed using a CASA Smart control panel. The delivery includes: Air heater, SET connection module, actuator and 3-way valve, 24 V transformer, requisite sensors and instructions.

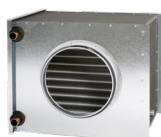

SDHW125	Heating coil package Ø125
SDHW160	Heating coil package Ø160

Brine air heater/cooler for ground source heat pump

In a property equipped with a ground source heat pump, a brine air heater/cooler for the heat pump can be installed in the outdoor air duct. In the winter it heats the air taken in and ensures that the ventilation unit operates with the greatest efficiency even in extreme cold. In the summer, the medium in the ground circuit is used to cool the building. The control technology in CASA Smart automatically ensures that the air heater/cooler is utilised optimally all year round. The delivery includes: heating/cooling coil, wall mounting bracket/ceiling mounting frame, an effective 4-row air cooler for cooling medium, SET connection module, coarse filter, requisite sensors and instructions and drip tray for condensate water: condensation water outlet with 3/8" male thread.



SDHW250F	Heating/cooling coil Ø250, G4
----------	-------------------------------

Electric air heater

Can be used for preheating and is placed in the outdoor air duct to guarantee continuous ventilation under very cold conditions and permit balancing functions (fireplace function/function for a cooker hood) in the air handling unit without an integrated air heater for preheating. If the air heater is to be installed as a preheater, a FLK-filter needs to be installed in the duct in front of the preheater. An electric air heater can also be placed in the supply air duct and used as a reheater to maintain a comfortable supply air temperature under very cold conditions. The electric duct heater has built-in regulation and is controlled directly from a ventilation unit. The heater is connected using a separate power supply 230 V. The delivery includes: air heater, SET connection module, requisite sensors and instructions



SDHE125-1T	Electric heater Ø125
SDHE160-1T	Electric heater Ø160
FLK12	Prefilter box Ø125mm, G4
FLK16	Prefilter box Ø160mm, G4

Other accessories



Used for connection of external accessories, for example, damper, duct coils, etc.

SET	Connection module for control of the duct mounted air heater/cooler / control of shut-off dampers
POWER24V20W	SET / power source for actuators



The constant duct pressure function on the Smart ventilation unit attempts to regulate the fan speeds to maintain the duct pressure at the set value. Individual setting values for the duct pressure should be determined for each operating mode (away, home, boost). The operating mode can be switched as normal when the constant duct pressure function is used.

PTH	PTH Regulation for constant duct pressure
-----	---



Formed condensation insulation that is easy to install. Mounted on pipes or parts before insulation. Spliced securely with tape. Gives good protection against condensation deposits on cold ventilation ducts routed in warm areas.

9000476	Straight section, Ø125 mm, L1000
9000480	Elbow 90, Ø125
9000483	Splicing tape



Mounting frame with quick-fit connectors for mounting the ventilation unit on the ceiling or wall. Simplifies connection as the duct system can be fully installed prior to the installation of the ventilation unit.

PR085RKA	Mounting frame right-hand
PR085LKA	Mounting frame left-hand
WRWMB	Wall mounting bracket



The mounting frame has a moisture barrier which prevents moisture from entering the insulation in the attic joist floor and stops the air from the loft from coming down into the rooms.

PR085YP	Vapour barrier for mounting frame
---------	-----------------------------------



Duct mounted shut-off dampers type 4 and damper actuator 24 V with spring return. The damper closes in the event of a power failure or alarm when a risk of freezing exists. The damper actuator is electrically connected to a CASA SET-module. SET module and 24 V adapter is ordered separately as required.

SDD125	CASA Damper Ø125 24V
SDD160	CASA Damper Ø160 24V

Feel good **inside**



Swegon 