

SWIMMING POOL
AND SMALL ROOMS
DEHUMIDIFIERS
DDS DCS DVS DOS

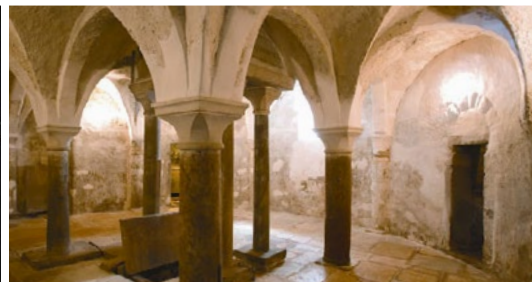

- Small swimming pools
- Book shops
- Libraries
- Greenhouses
- Museums
- Churches
- Crypts
- Cellar
- Archives
- Ironing rooms
- Warehouses (paper, cardboard box, ...)
- Rooms for food preservation and treatment (fish, meat, ...)



DDS DCS DVS DOS: CONDENSING DEHUMIDIFIER

HiDew always aims to design technologically advanced solutions, with the least environmental impact: the **DDS**, **DCS**, **DVS**, **DOS** series are available in a really wide range of models.

DDS Wall mounted or floor standing dehumidifiers, designed for dehumidification and heating of small swimming pools or ambiances where air treatment is required.

- Pre coated finned coils suitable for aggressive environment
- Dehumidification capacity from 46 to 290 l/day
- Airflow from 350 to 2000 m³/h



DCS Wall mounted dehumidifiers for mechanical room, designed for dehumidification and heating of small swimming pools or ambiances where air treatment is required.

- Pre coated finned coils suitable for aggressive environment
- Dehumidification capacity from 46 to 290 l/day
- Airflow from 350 to 2000 m³/h



DVS Vertical floor standing dehumidifiers, designed for dehumidification and heating of small swimming pools or ambiances where air treatment is required.

- Pre coated finned coils suitable for aggressive environment
- EC fan with inverter (standard)
- Dehumidification capacity from 52 to 225 l/day
- Airflow from 450 to 1400 m³/h



DOS Ductable false-ceiling dehumidifiers, designed for dehumidification and heating of small swimming pools or ambiances where air treatment is required.

- Pre coated finned coils suitable for aggressive environment
- EC fan with inverter (standard)
- Dehumidification capacity from 52 to 225 l/day
- Airflow from 450 to 1500 m³/h



PRINCIPLE SCHEME

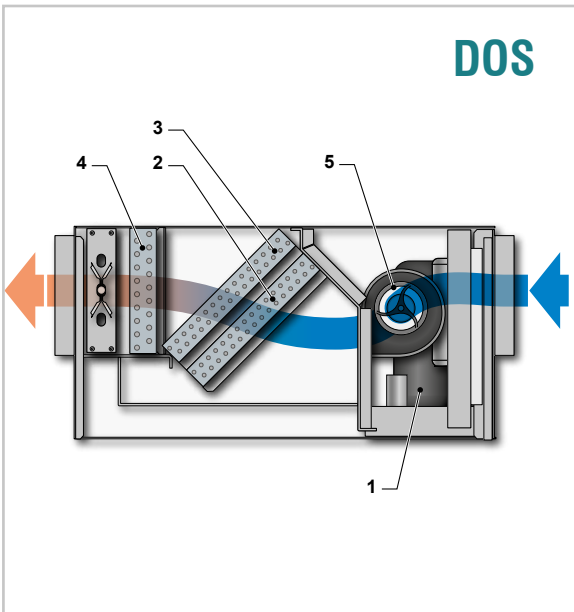
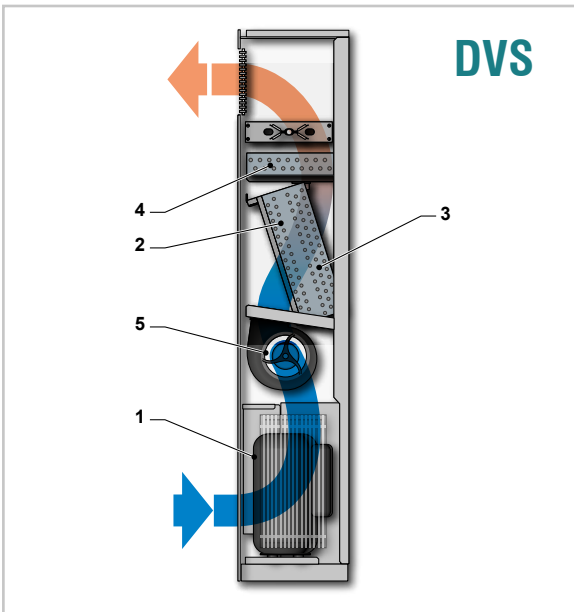
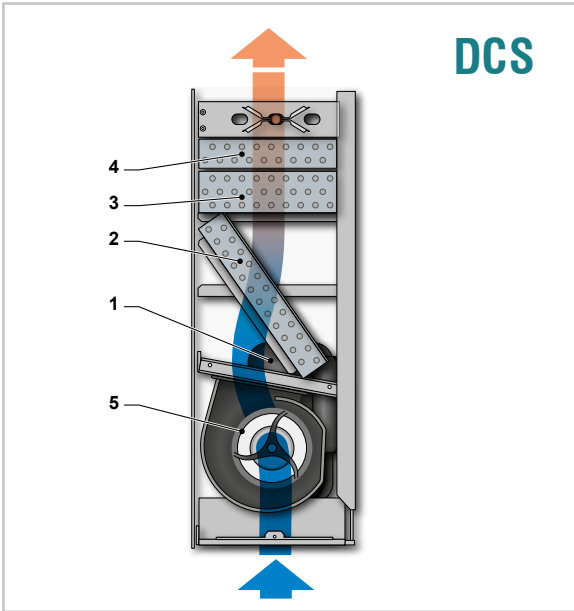
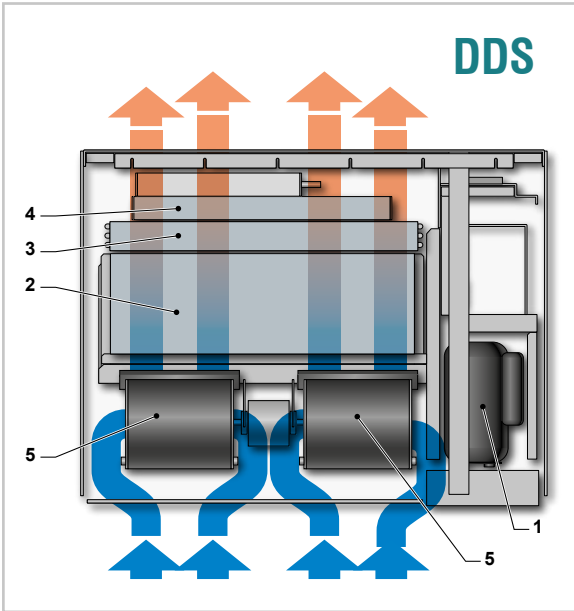

- 1 Compressor, R410A refrigerant
- 2 Evaporator
- 3 Condenser
- 4 Post - heating water coil with 3 ways motorized valve
- 5 Fan: Centrifugal models DDS – DCS, Centrifugal EC models DVS – DOS

ADVANCED CONTROL

Unit allows to control relative humidity through probes on the display.
Unit could function in three modes:

- **Ventilation:** air treatments off, only fans operate
- **Dehumidification:** compressor on, air dehumidified
- **Heating:** compressor on, air dehumidified and heated (hot water coil and/or electrical heaters)

Ventilation has three speeds and it is automatically managed depending on active request. It is present a clock card with time bands: 7 daily programs, 24 time bands per day, settable parameters: unit on / off, humidity and temperature. User terminal could be remote, unit will install an on board temperature and humidity probe, a cable for installation of remote user terminal is supplied (optional).

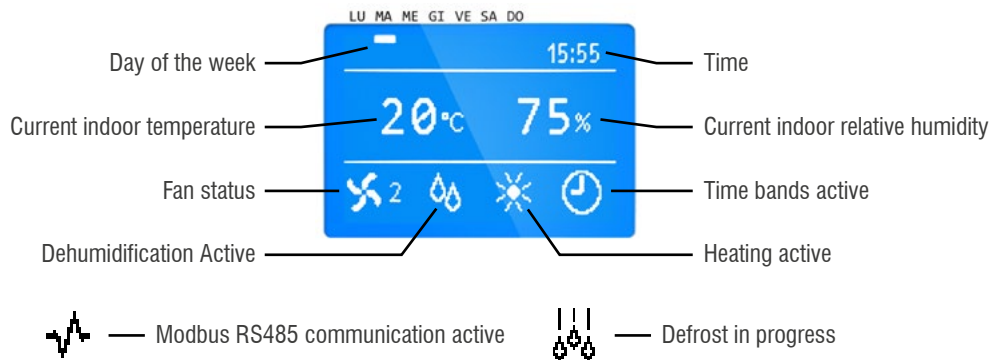

OPERATING LIMITS

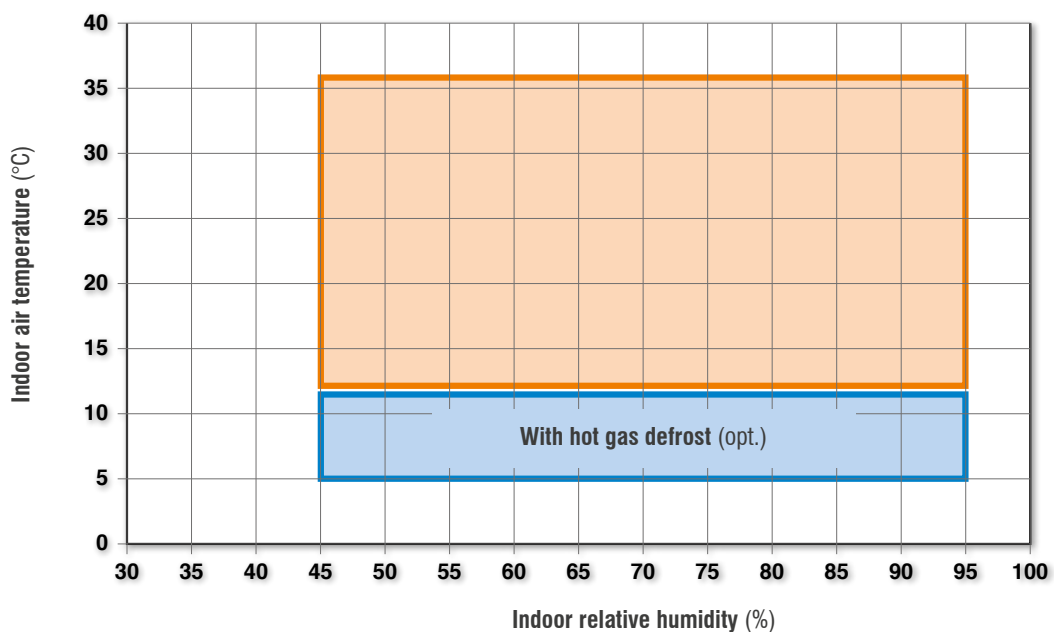

INSTALLATION

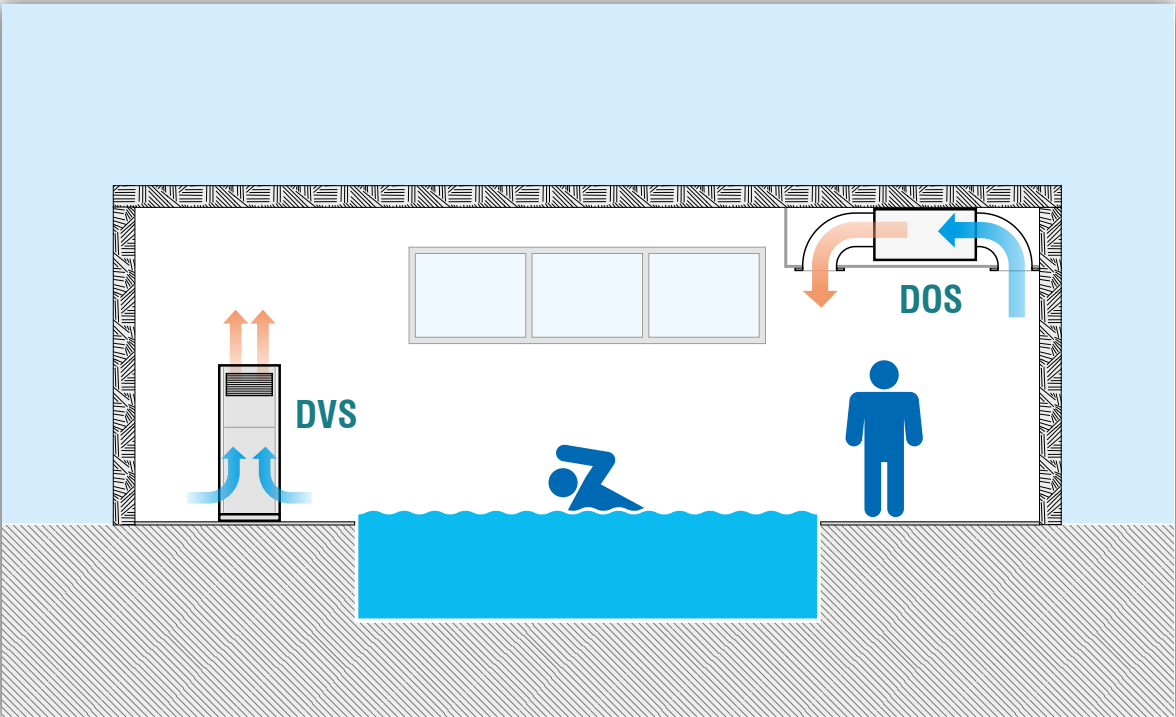
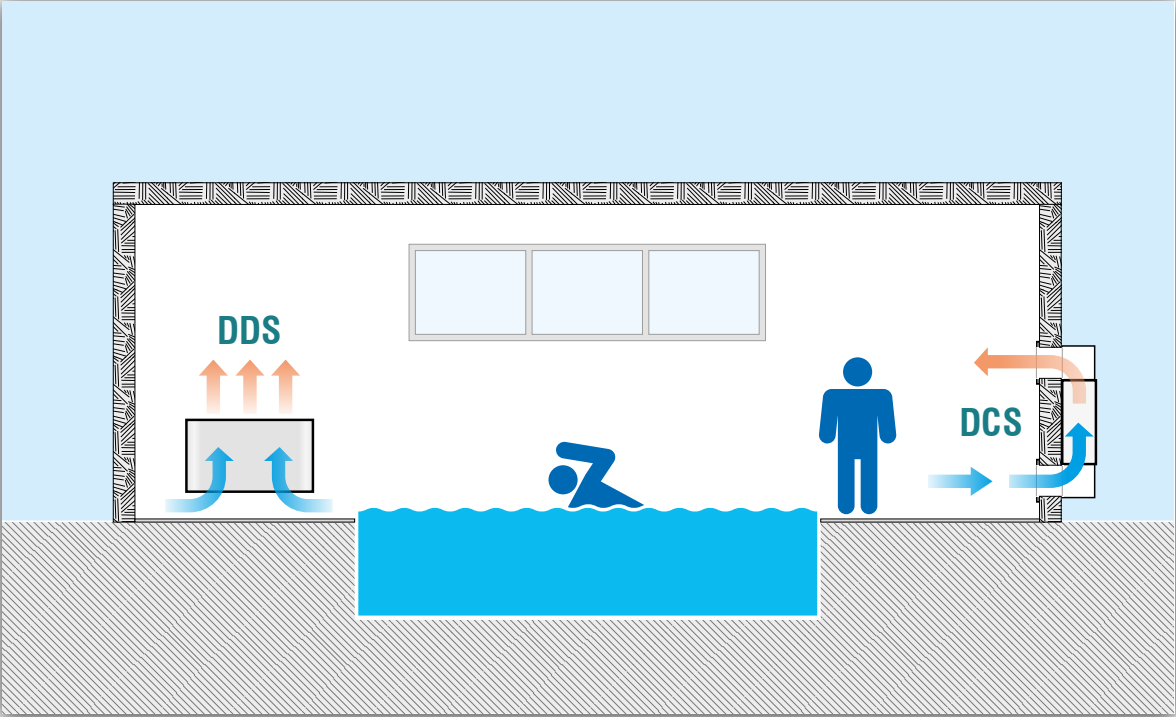

RANGE

	40	50	60	70	90	100	160	190	210	230	300
DDS											
DCS											
DVS											
DOS											



QUICK CHOICE GRAPHS

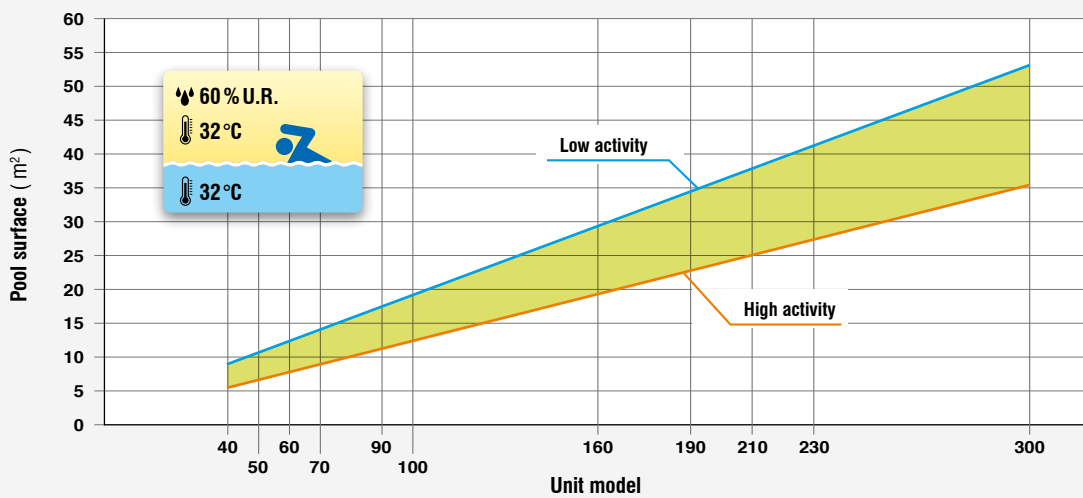
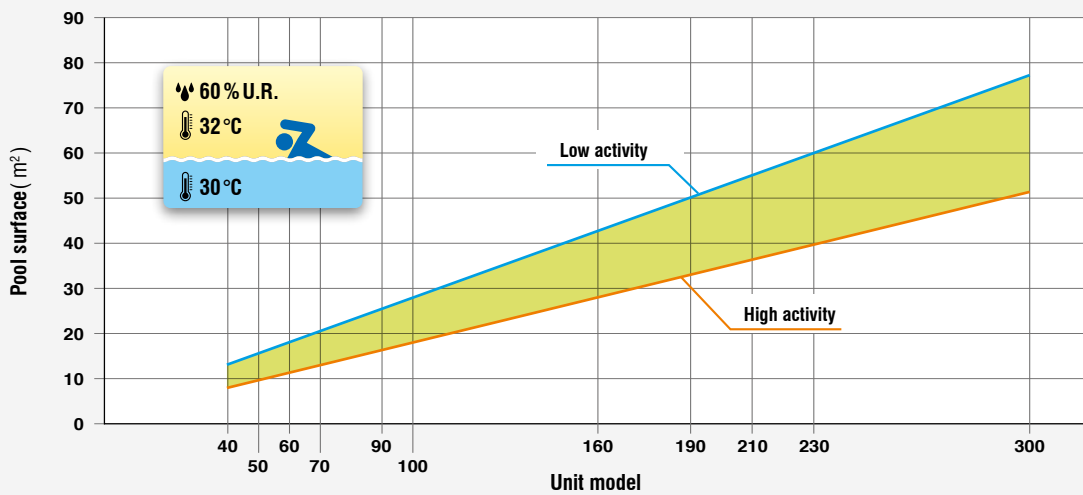
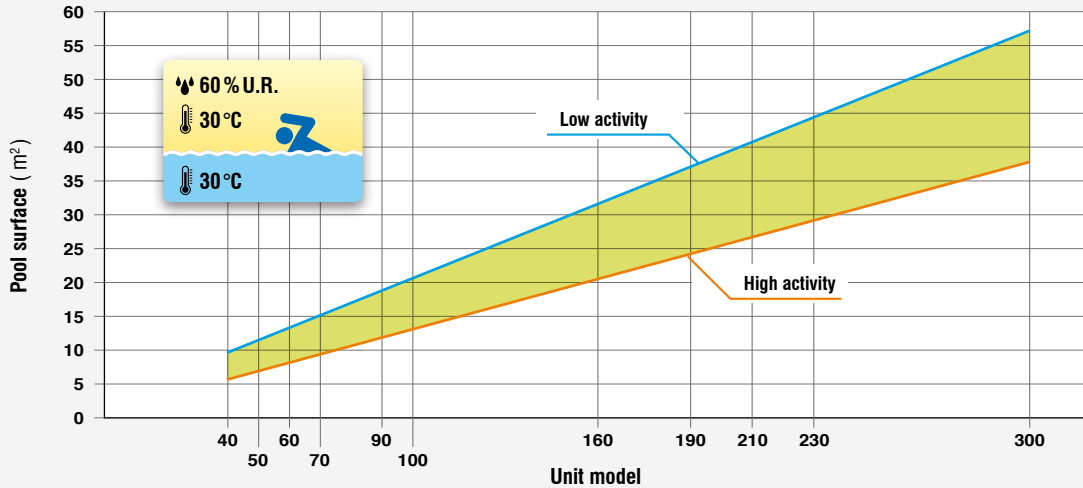

HiDew srl informs that quick choice graphs are only exemplificative and so they are subject to mandatory check by a qualified technician before the installation.
The graphs do not replace in any way the necessary technical project.

QUICK CHOICE GRAPHS

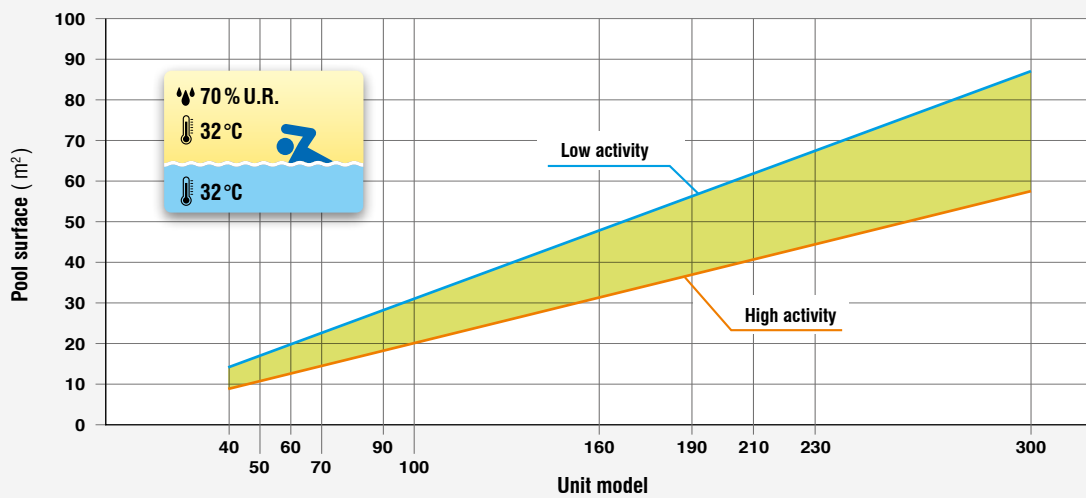
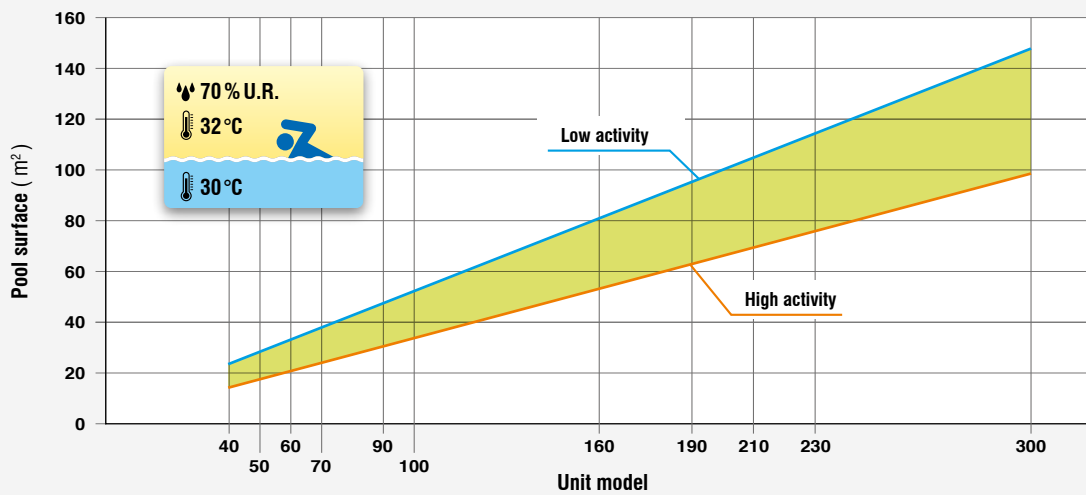
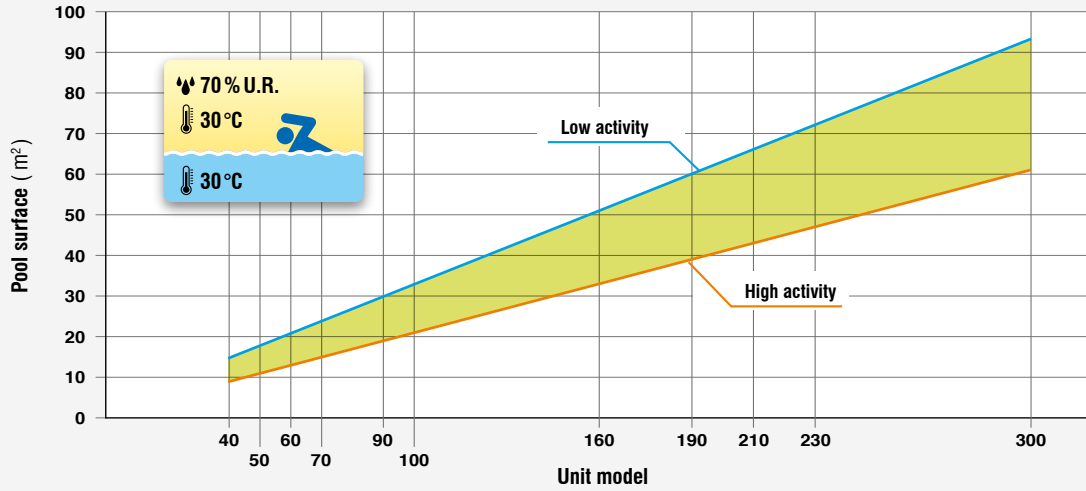

HiDew srl informs that quick choice graphs are only exemplificative and so they are subject to mandatory check by a qualified technician before the installation. The graphs do not replace in any way the necessary technical project.

OPTIONS

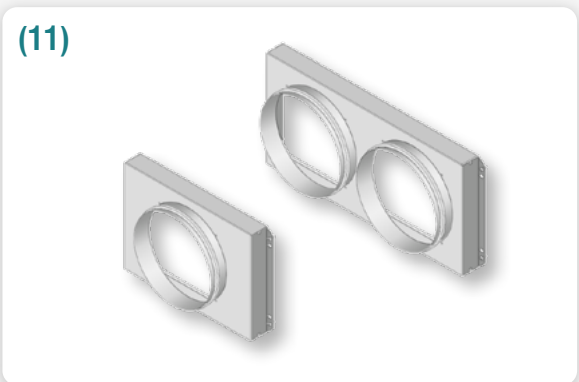
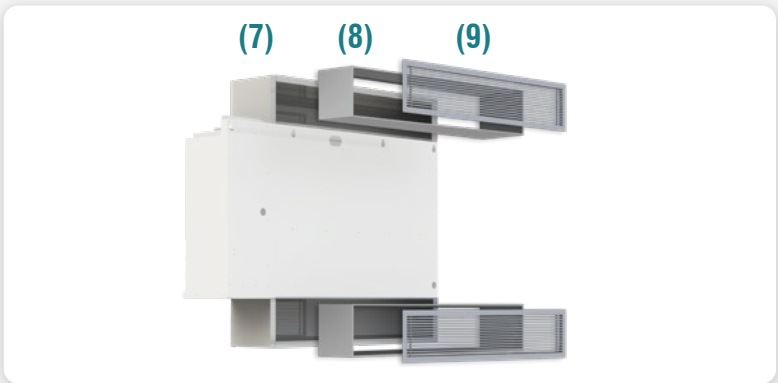
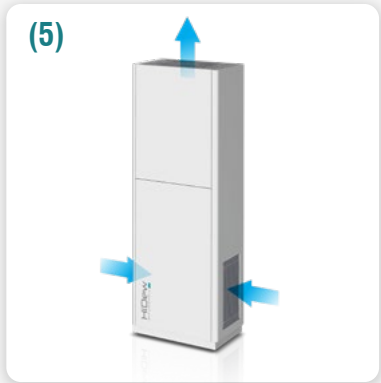
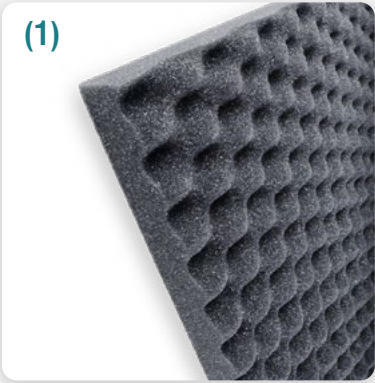

OPTIONS

OPTIONS DDS

- Hot water coils with 3 ways valve *
- Coils with epoxy coating
- Electrical heaters *
- EC electronic fan with inverter
- Hot gas defrost
- Silent version **(1)**
- Kit for display at distance (10 o 20 m) **(2)**
- Serial board RS485: Modbus **(3)**
- Feet kit for floor installation **(4)**
- Wooden cage

* *Alternative options for sizes 40, 50 and 60*

OPTIONS DVS

- Hot water coils with 3 ways valve
- Coils with epoxy coating
- Electrical heaters
- Hot gas defrost
- Display mounted on the machine
- Silent version **(1)**
- Kit for display at distance (10 o 20 m) **(2)**
- Serial board RS485: Modbus **(3)**
- Kit rectangular flange, top supply **(5)**
- Kit rectangular flange, back supply **(6)**
- Wooden cage

OPTIONS FOR SPECIAL APPLICATIONS

- Power supply 60 Hz

OPTIONS DCS

- Hot water coils with 3 ways valve *
- Coils with epoxy coating
- Electrical heaters *
- EC electronic fan with inverter
- Hot gas defrost
- Silent version **(1)**
- Kit for display at distance (10 o 20 m) **(2)**
- Serial board RS485: Modbus **(3)**
- Supply and recovery air plenum **(7)**
- In wall ducted plenum **(8)**
- Supply and recovery air grilles **(9)**
- Wooden cage

* *Alternative options for sizes 40, 50 and 60*

OPTIONS DOS

- High efficiency air filter, class G4
- Hot water coils with 3 ways valve
- Coils with epoxy coating
- Electrical heaters **(10)**
- Hot gas defrost
- Standard connection cable 2 m (Opt. 5, 10 or 20 m)
- Silent version **(1)**
- Kit supply flange for circular ducts Ø 250 mm **(11)**
- Kit extraction flange for circular ducts Ø 250 mm **(11)**
- Serial board RS485: Modbus **(3)**
- Wooden cage

TECHNICAL DATA

		DDS - DCS											
		40	50	60	70	90	100	160	190	210	230	300	
Dehumidification capacity ¹	l/day	46	52	61	68	92	99	165	186	213	226	300	
Circuits / Compressors		1 / 1			1 / 1			1 / 1		1 / 1		1 / 1	
Type of compressor		Rotary			Rotary			Rotary		Scroll		Scroll	
Refrigerant		R410A			R410A			R410A		R410A		R410A	
Airflow - ventilation	m ³ /h	250	250	250	350	350	350	530	530	1500	1500	1800	
Airflow - dehumidification	m ³ /h	350	450	500	600	700	800	1000	1200	1500	1500	2000	
Airflow - heating	m ³ /h	400	550	650	700	850	900	1250	1350	1800	1800	2350	
Standard centrifugal fan available static pressure	Pa	40	40	40	40	40	40	40	40	40	40	40	
EC centrifugal fan available static pressure	Pa	275	250	225	200	175	100	120	90	60	60	40	
Hot water coil nominal heating capacity ²	kW	3,7	4,5	4,5	6,1	6,8	7,5	10,1	11,5	14,5	14,5	17,7	
Nominal water flow	l/h	320	390	390	525	585	645	870	870	1250	1250	1525	
Water pressure drop including valve	kPa	11	16	16	35	42	50	24	31	52	52	73	
Electrical heaters power	kW	1,5	1,5	1,5	2,0	3,6	3,6	4,0	4,0	7,2	7,2	7,2	
Maximum absorbed electrical power ³	kW	0,9	0,9	1,0	1,0	1,7	1,7	2,6	2,7	3,6	3,9	5,0	
Power supply	V/ph/Hz	230 / 1 + N / 50							400 / 3 + N / 50				
Sound pressure ⁴	dB(A)	43	45	46	47	48	49	51	53	54	55	57	
Weight	kg	46			55			88		100		102	

1 - Dehumidification capacity is declared with ambient air at 30°C / 80% RH.

2 - Hot water coil capacity is declared with ambient air at 30°C, water inlet 80°C and outlet 70°C.

3 - Absorbed electrical power is declared with ambient air at 30°C / 80% RH and nominal air flow.

4 - Pressure sound level measured in free field at 1 m from the unit.

TECHNICAL DATA

		DVS - DOS							
		Model size: ▶		50	70	90	100	160	190
Dehumidification capacity ¹	l/giorno	52	68	92	99	165	186	213	226
Circuits / Compressors		1 / 1				1 / 1		1 / 1	
Type of compressor		Rotary				Rotary		Scroll	
Refrigerant		R410A				R410A		R410A	
Airflow - ventilation	m ³ /h	250	150	150	175	240	250	275	275
Airflow - dehumidification	m ³ /h	450	600	700	800	1000	1200	DVS 1400 DOS 1500	DVS 1400 DOS 1500
Airflow - heating	m ³ /h	550	720	800	850	1200	1300	1550	1550
EC centrifugal fan available static pressure DVS	Pa	250	200	175	150	230	200	160	160
EC centrifugal fan available static pressure DOS	Pa	250	200	175	150	230	200	150	150
Hot water coil nominal heating capacity ²	kW	5,2	6,1	6,8	7,5	10,4	11,9	13,3	13,3
Nominal water flow	l/h	390	525	585	645	895	1025	1145	1145
Water pressure drop including valve	kPa	18	33	40	47	34	44	55	55
Electrical heaters power	kW	1,5	2	2	2	4	4	4	4
Maximum absorbed electrical power ³	kW	1,2	1,0	1,5	1,6	2,4	2,6	3,8	3,8
Power supply	V/ph/Hz	230 / 1 + N / 50						400 / 3 + N / 50	
Sound pressure ⁴	dB(A)	45	46	47	48	50	52	53	54
Weight DVS	kg	80				140		160	
Weight DOS	kg	84				147		168	

1 - Dehumidification capacity is declared with ambient air at 30°C / 80% RH.

2 - Hot water coil capacity is declared with ambient air at 30°C, water inlet 80°C and outlet 70°C.

3 - Absorbed electrical power is declared with ambient air at 30°C / 80% RH and nominal air flow.

4 - Pressure sound level measured in free field at 1 m from the unit.

GRAPH READING EXAMPLE

Performance graph reading example

Air temperature 20 °C
Air relative humidity 80 %

The graph allows to determine dehumidification capacity, in this case equal to 30 l/day

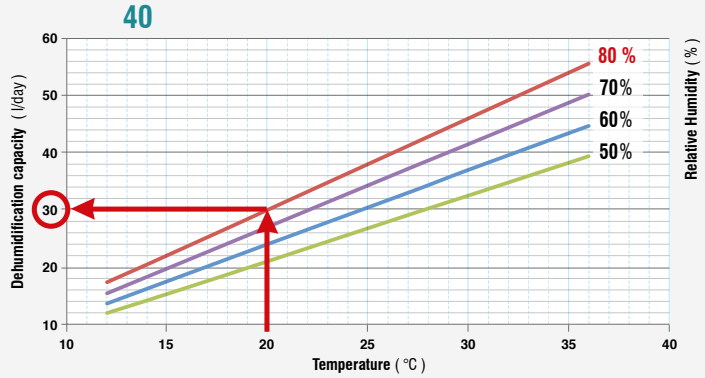

PERFORMANCE CURVES

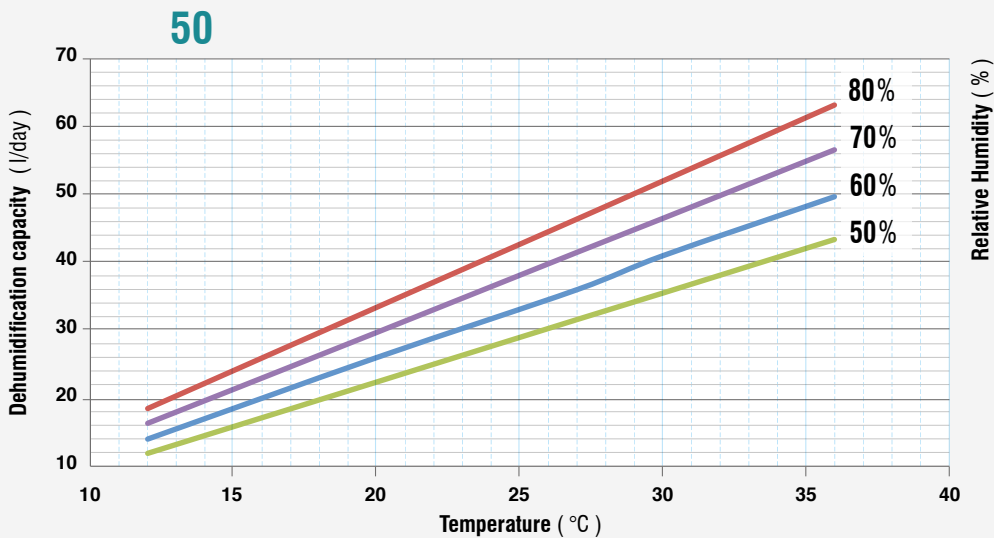
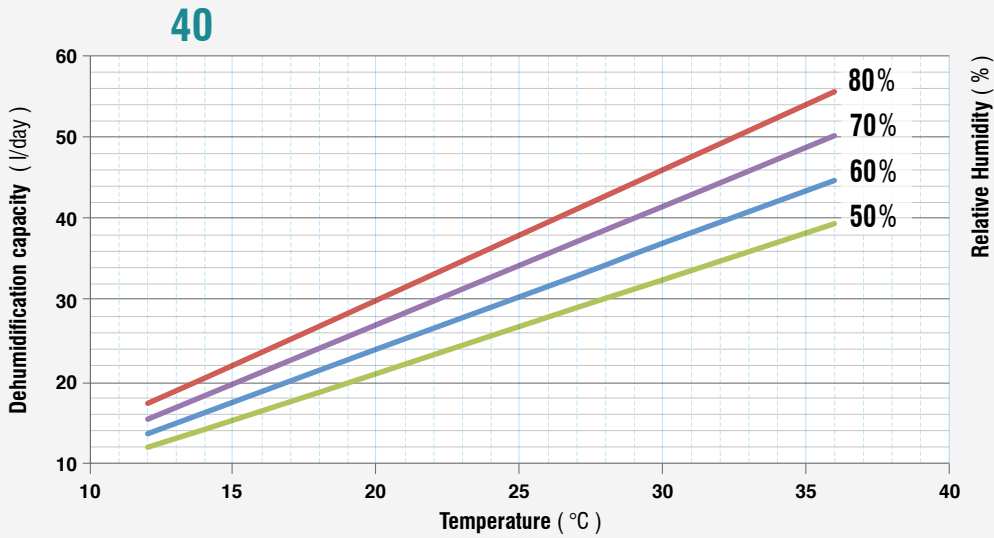

PERFORMANCE CURVES

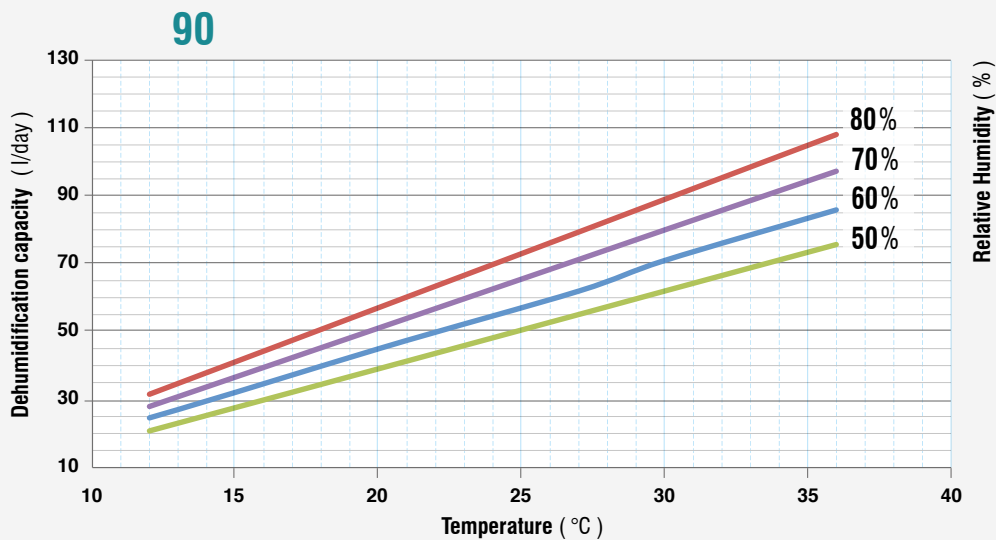
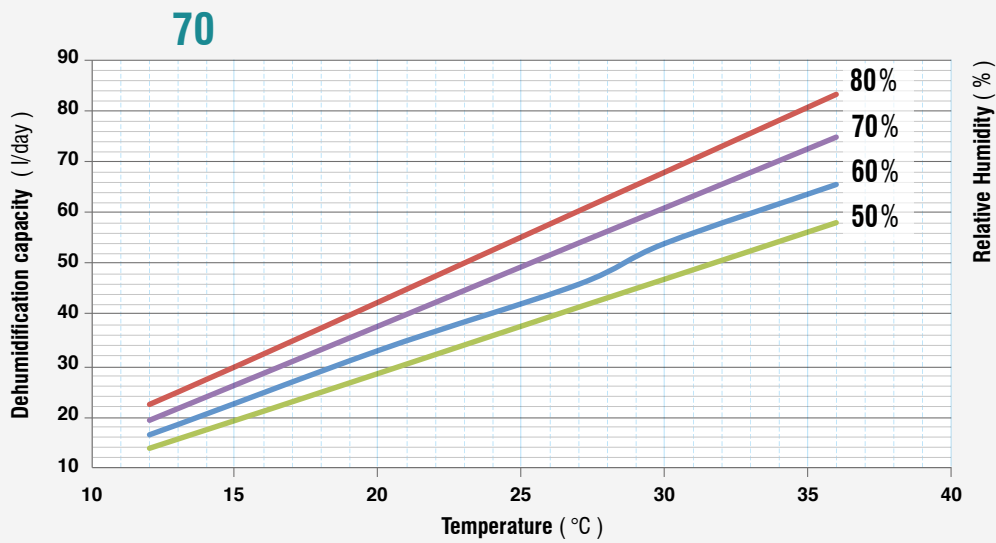
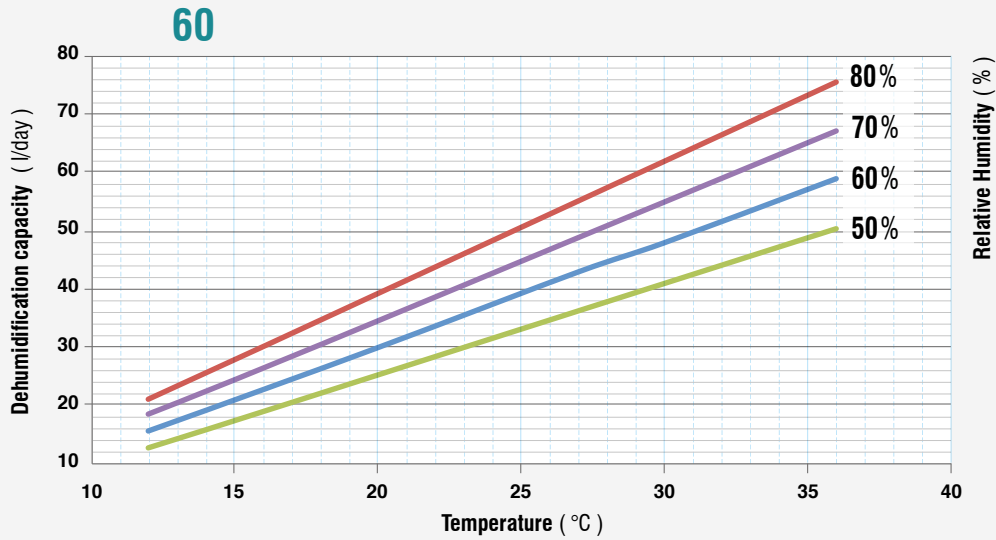

PERFORMANCE CURVES

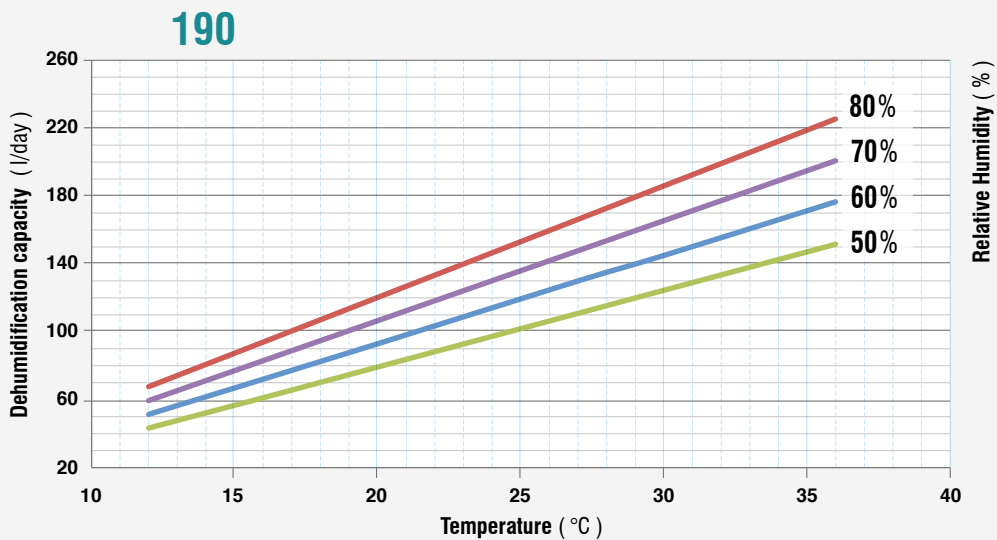
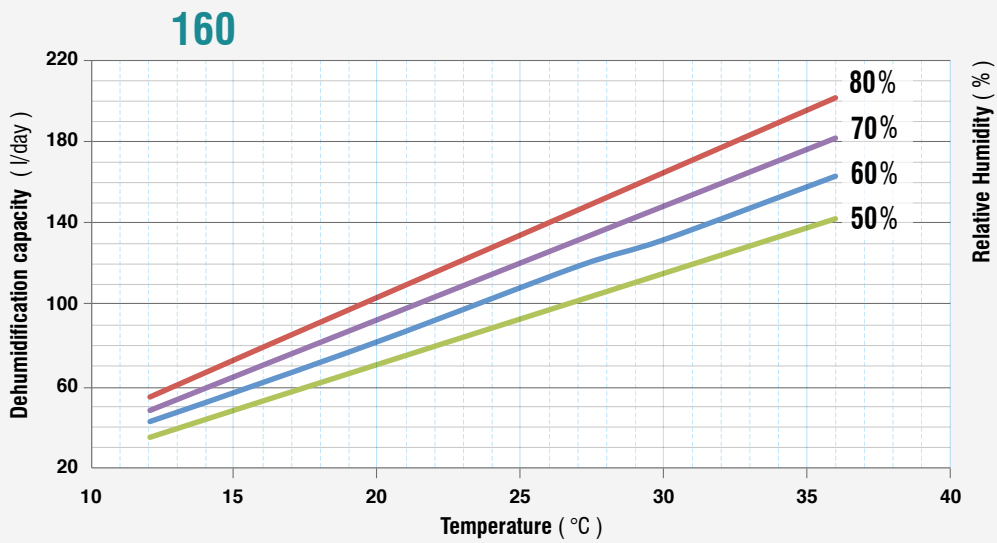
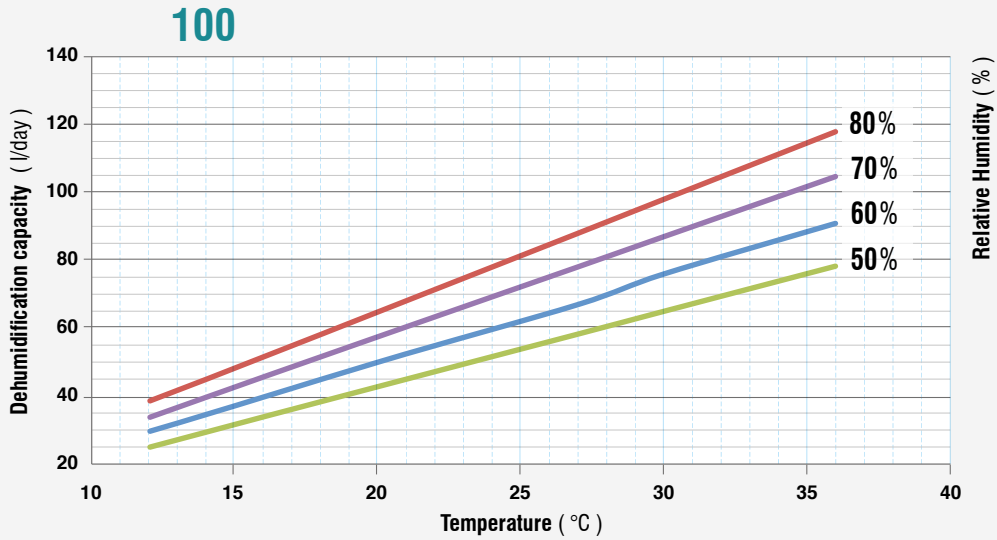

PERFORMANCE CURVES

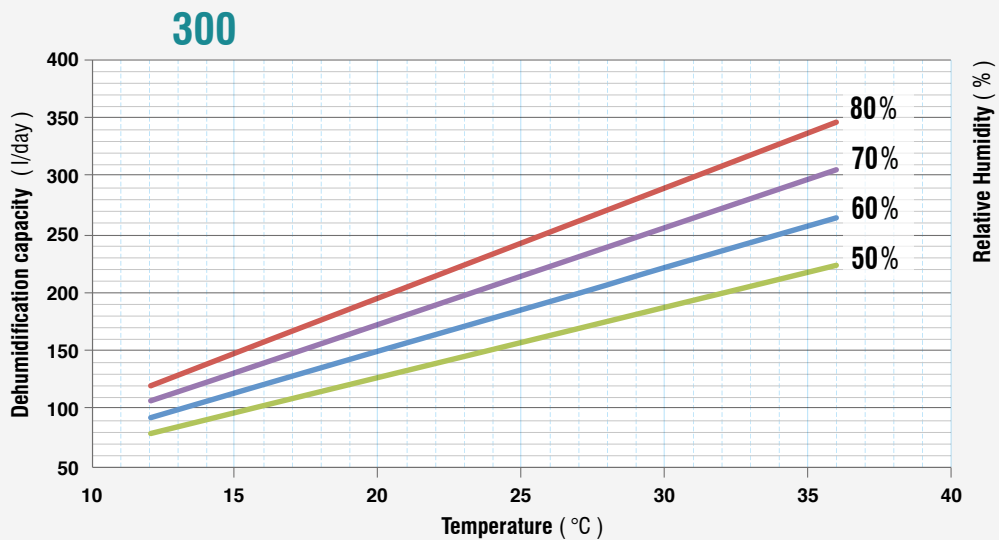
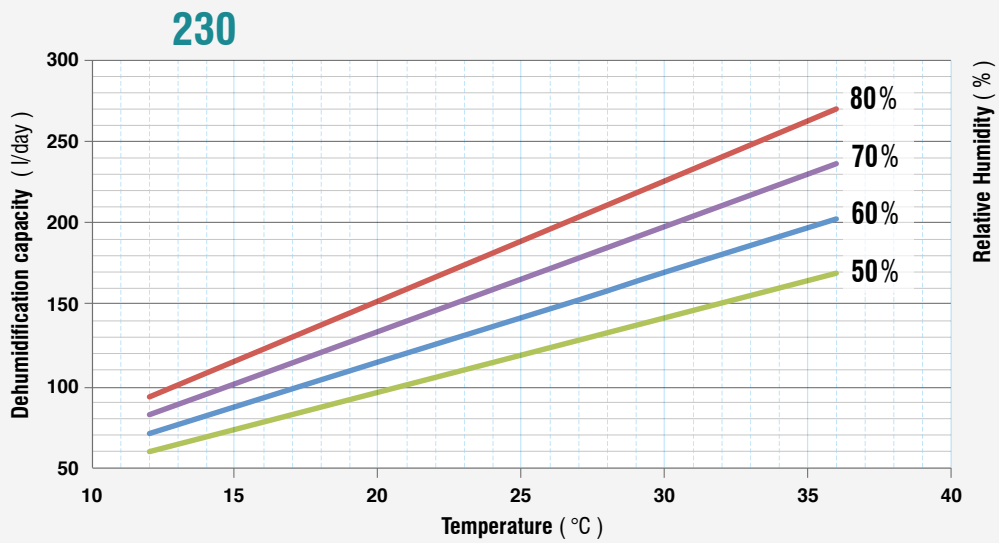
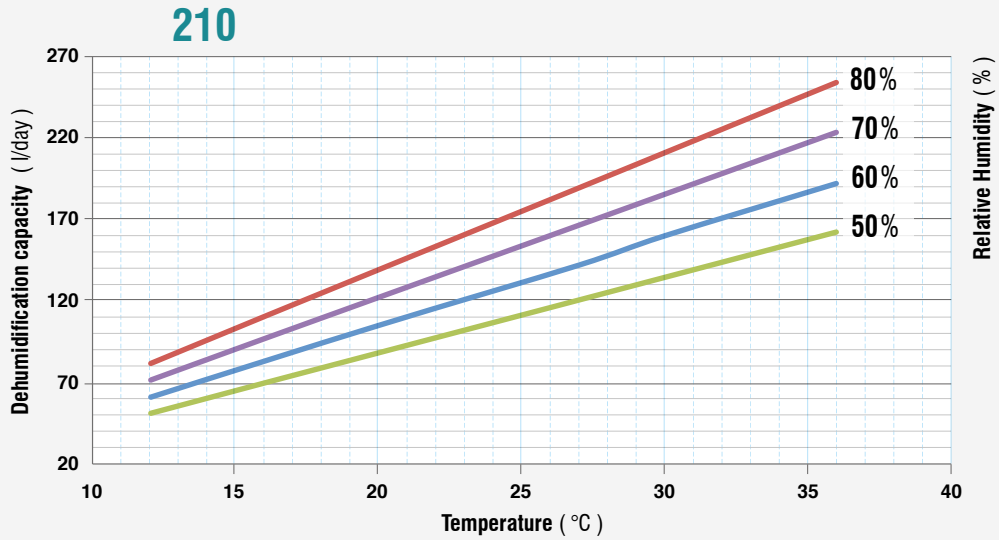

DIMENSIONS AND CLEARANCES

DDS

DDS	DIMENSIONS				CLEARANCES				
	A [mm]	B [mm]	C [mm]	D ¹ [mm]	E [mm]	F [mm]	G [mm]	H [mm]	I [mm]
40	845	282	782	882	50	100	200	250	600
50	845	282	782	882	50	100	200	250	600
60	845	282	782	882	50	100	200	250	600
70	1045	282	782	882	50	100	200	250	600
90	1045	282	782	882	50	100	200	250	600
100	1045	282	782	882	50	100	200	250	600
160	1345	333	852	952	50	100	200	250	600
190	1345	333	852	952	50	100	200	250	600
210	1545	333	852	952	50	100	200	250	600
230	1545	333	852	952	50	100	200	250	600
300	1545	333	852	952	50	100	200	250	600

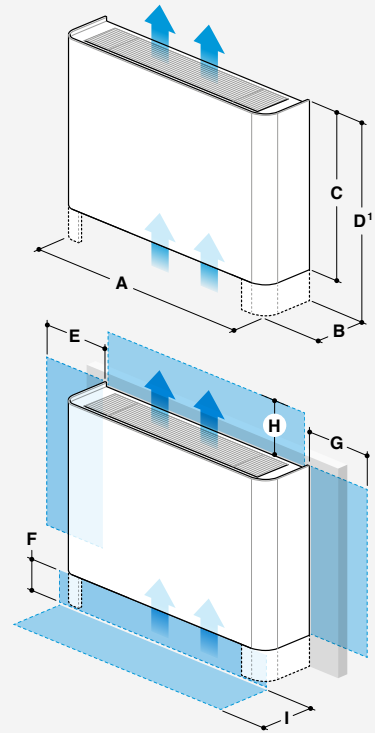

1 - Floor installation feet height: 100 mm

DCS

DCS	DIMENSIONS							CLEARANCES			
	A [mm]	B [mm]	C [mm]	D [mm]	E [mm]	F [mm]	G [mm]	H ² [mm]	I [mm]	L [mm]	M [mm]
40	800	257	745	230	1205	570	50	150	300	250	600
50	800	257	745	230	1205	570	50	150	300	250	600
60	800	257	745	230	1205	570	50	150	300	250	600
70	1000	257	745	230	1205	770	50	150	300	250	600
90	1000	257	745	230	1205	770	50	150	300	250	600
100	1000	257	745	230	1205	770	50	150	300	250	600
160	1300	306	815	230	1275	1020	50	150	300	250	600
190	1300	306	815	230	1275	1020	50	150	300	250	600
210	1500	306	815	230	1275	1220	50	150	300	250	600
230	1500	306	815	230	1275	1220	50	150	300	250	600
300	1500	306	815	230	1275	1220	50	150	300	250	600

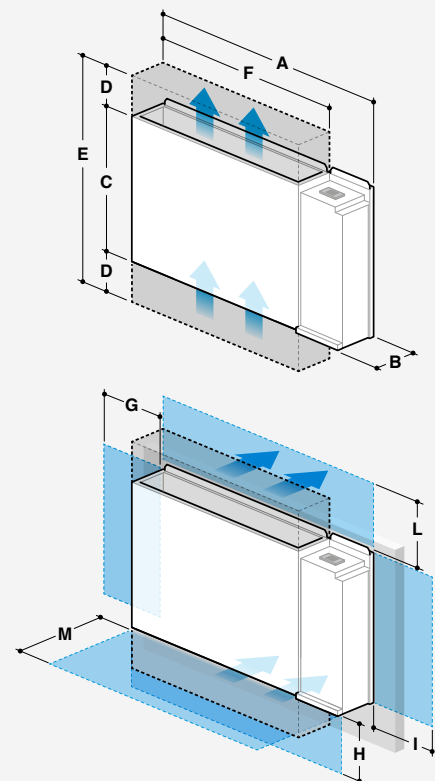

2 - With plenum H=300 mm

DIMENSIONS AND CLEARANCES

DVS

DVS	DIMENSIONS			CLEARANCES			
	A [mm]	B [mm]	C [mm]	D [mm]	E ³ [mm]	F [mm]	G [mm]
50	550	330	1652	300	500	300	600
70	550	330	1652	300	500	300	600
90	550	330	1652	300	500	300	600
100	550	330	1652	300	500	300	600
160	750	330	1652	300	500	300	600
190	750	330	1652	300	500	300	600
210	750	330 <td 1652	300	500	300	600	
230	750	330	1652	300	500	300	600

3 - Only for DVS cwith top supply.

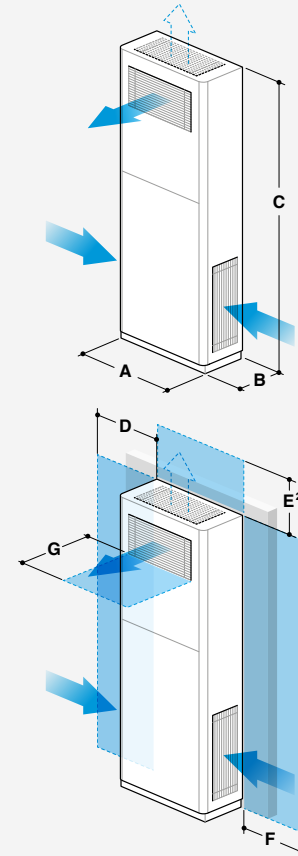

DOS

DOS	DIMENSIONS			CLEARANCES			
	A [mm]	B [mm]	C [mm]	D [mm]	E [mm]	F [mm]	G [mm]
50	1105	801	410	500	500	500	600
70	1105	801	410	500	500	500	600
90	1105	801	410	500	500	500	600
100	1105	801	410	500	500	500	600
160	1105	1051	510	500	500	500	600
190	1105	1051	510	500	500	500	600
210	1105	1051	510	500	500	500	600
230	1105	1051	510	500	500	500	600

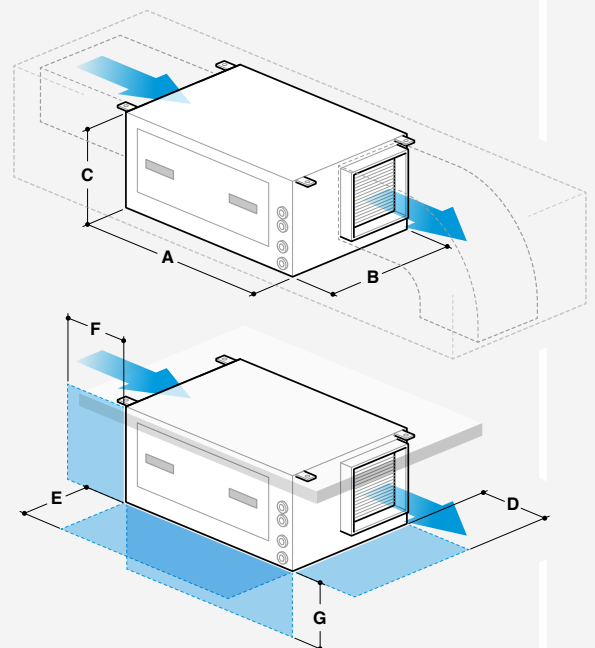

HiDew
Dehumidifiers 

HiDew S.r.l.

Headquarter : Via dell'Artigianato, 5 35026 Conselve (PD) - Italy
Phone: +39 049 9502511

Registered Office : Viale Spagna, 31/33 35020 Tribano (PD) - Italy
Phone: +39 049 9588511 Fax: +39 049 9588522

www.hidew.it info@hidew.it

HD-DDS6EN-2023

MADE IN ITALY



HiDew S.r.l. reserves the right to change the specifications and other information contained herein without notice. No part of this publication may be reproduced without the prior written permission of HiDew S.r.l.