



RADIANT CEILING SYSTEMS

Tailor made climate ceiling solutions for a pleasant room climate

« Feel good inside » that's our promise

We offer advice to our partners throughout the construction process – from the initial design until commissioning. During the design phase of your project, we will provide you with documentation on sustainable building design, recommendations for low energy systems and cost estimates for the various solutions.

Whilst developing your building concept, we will help you decide on the room climate criteria, based on the user requirements in relation to thermal comfort.

Our radiant ceilings impress, thanks to their high energy efficiency. This allows the user to set higher system temperatures (water, air) for cooling than with conventional systems. Conversely, system temperatures can be set lower for heating. These advantages result in very high energy savings across all system operating phases.

A further advantage is the thermal comfort afforded by the system. Rooms in which the temperature is controlled by a radiant ceiling are very comfortable because they are not affected by draughts and the radiant heating or cooling is perceived as very natural and pleasant.

- **Competent support across every project phase**
competence forms our basis and delivers your benefit
- **Flexible systems** which can be tailored to the specific requirements of your project
- **Efficient execution** that brings you advantages – because time is an important economic factor

We look forward to a long and successful collaboration with you!

Digital overview brochure



Tailor made climate ceiling solutions

Professional - Flexible - Efficient

April 2025

CONTENTS

Professional - Flexible - Efficient

Project management.....	6
Production centres.....	6
Research & development.....	6
3D-design with BIM.....	6

Physical principles

Radiant cooling.....	8
Building mass connection.....	8
Sound absorption.....	9

Hybrid systems with building mass connection

U4X Hybrid system.....	10 / 44
VARICOOL TKM Hybrid system.....	12 / 44
CAURUS Hybrid system.....	14 / 44
AQUILO Hybrid system.....	16 / 45
VENTAMIC Hybrid system.....	18 / 45

Ceiling sails and modules

A11-S Radiant metal ceiling sail.....	20 / 46
SPECTRA M-S Radiant metal ceiling sail.....	22 / 46
AKUSTIKTHERM (TABS).....	24 / 46

Closed radiant ceilings

A11-C Radiant metal ceiling.....	26 / 48
SPECTRA M-C Radiant metal ceiling.....	28 / 48
VARICOOL UNI Radiant ceiling jointless.....	30 / 48
VARICOOL AP Radiant ceiling jointless.....	32 / 49
ARCHISONIC® Acoustic baffle.....	34 / 49

High performance modules / Radiant baffle

ALBATROS High performance module.....	36 / 50
OPTI Y High performance module.....	38 / 50
SOFTLINE High performance module.....	40 / 50
METAL LINE Radiant baffle.....	42 / 51

Symbols

Water	
Cooling / heating	
Acoustics	
Integral components	
Building mass connection	
Invisible air intake	

Optimal indoor climate with Barcol-Air products

The ideal room climate is a must for wellbeing in offices, conference suites and hotel rooms.

Our radiant ceiling systems for heating and cooling are inspired by the natural heat radiation of the sun and are based on extremely efficient heat transfer. The systems operate with over 60 % radiation, whilst the rest is accounted for by natural convection. This form of thermal transfer makes it possible to achieve optimum temperature control in the room. More energy efficient room temperature settings are possible in both summer and wintertime, without impacting comfort.

Thanks to the radiation principle, surface temperatures in the room are regulated without generating noise or draughts, making it possible to keep the air temperature slightly lower when heating and slightly higher when cooling than with conventional systems. These systems also work perfectly with renewable energy systems such as heat pumps, therefore leading to lower energy consumption and the associated reduction in operating costs

Our versatile radiant ceiling systems are suitable for a range of ceiling constructions including metal ceiling systems, free-hanging sails and special geometries. A further area of application is the thermal activation of plasterboard ceilings, which can be used to create large, jointless ceiling installations.

« The best indoor climate for people and the environment »



Professional - Flexible - Efficient

Comprehensive project management – we pursue our passion and ease your burden

We offer advice to our partners throughout the construction process – from the initial design until the building is in use. During the design phase of your project, we will provide you with documentation on sustainable building design, recommendations for low energy systems and cost estimates for the various solutions. Whilst developing your building concept, we will help you decide on the room climate and thermal comfort criteria, based on the user requirements in relation to heating and cooling.

Modern production centres in Germany

Our own production centres for radiant ceilings guarantee the manufacture of high quality systems from Barcol-Air, both in terms of materials and production technology. Furthermore, customers can also benefit from a high degree of delivery flexibility and unbeatable delivery punctuality.

- CNC-controlled production plant
- Laser spot welding process
- Modern production processes
- Interface to Clim@Tool



or



SCAN ME

Research & development

Barcol-Air operates a climate laboratory at its headquarter in Switzerland for product development, where it also carries out various measurements and analyses at project-specific level. This means it is possible to test and confirm the faultless functionality of the solutions as early as the planning phase.

- Proof of performance of project-specific radiant ceiling solutions
- Static and dynamic performance measurements of radiant ceiling systems
- Indoor air speed and thermal comfort measurements
- Special measurements (e.g. control strategy, cold air drop, etc.)



or



SCAN ME

3D design with BIM

Building Information Modeling (BIM) is a digital, model-based planning method for buildings (and other structures) that is used to create and manage data in a 3D model and remains usable from the planning, construction and throughout the operational process.

We support digital building modeling by providing 3D models for climate ceilings (project-specific) and ventilation components using Revit BIM software.



Physical principles

The principle and advantages of thermal radiation

People are sensitive not only to the air temperature, but thermal radiation too. Radiant ceilings control the temperatures of surfaces in a room through the exchange of radiation, not via the air. This means that the air temperature can be set higher in cooling mode and does not need to be cooled to the extent required with conventional systems (for example, 26 °C rather than 23 °C). When heating, on the other hand, the room temperature can be set slightly lower without adversely affecting comfort (e.g. 20 °C rather than 23 °C). This results in high thermal comfort among room users, whilst simultaneously reducing the energy consumed by the system.

Ceiling response speed with radiant cooling

When a radiant ceiling is switched on, the effect is almost instantly discernible. Thermal radiation travels at the speed of light – in contrast to conventional systems, which have to control the temperature of all the air in the room.

 You can find more information in our document « The Basic Principles of Radiant Ceilings »



SCAN ME

The advantages of radiant ceiling systems with building mass connection

Energy efficient

A radiant ceiling with a building mass connection, which is operated and controlled correctly, can be run exclusively at night and in free cooling mode for most of the year (excluding heatwaves). The reduced heating loads during periods other than heatwaves can then be temporarily stored by the building mass into the night.

A proportion of the cooling load is temporarily stored in the concrete ceiling during the day. It does not have to be dissipated via the radiant ceiling in the daytime, but rather is transferred during the night. Overnight, the water from the radiant ceiling can then discharge the concrete again (with lower electricity costs and at lower outside temperatures), which means that the electricity required by the refrigeration unit is significantly lower, or can even be largely eliminated in the case of free cooling.

The design of the refrigeration unit for peak loads can be reduced by 10 to 20 %.

Environmentally responsible

Increasing the COP of the refrigeration unit considerably reduces the electric portion of the refrigeration process. As soon as it is possible to proceed with free cooling, no electrical energy is needed for refrigeration besides the pump output. This leads to a dramatic reduction in CO₂ emissions.

Cost efficient

Overall, this results in the following improvements on the cost side:

- Lower investment costs due to smaller refrigeration unit and smaller or fewer cooling coils on the ceiling panels and/or smaller ceiling sails.
- Lower running costs thanks to reduced energy costs, most of which are at the night tariff.
- Higher flow temperature possible due to smaller loads which are dissipated during the day, leading to better COP of the refrigeration unit.

 Further information is available in our document « Radiant Ceilings with Building Mass Connection »



SCAN ME



Image: © Mark Seelen

Sound absorption with radiant ceilings

The ceiling is usually the largest clear surface in a room that can be used effectively for acoustic purposes. It is also horizontal and always relatively close to the source of the noise, which makes it ideal for absorbing sound from the room. Having taken over 200 sound absorption measurements, we can make highly substantiated statements about sound absorption with radiant ceilings.

Room acoustics are an important element of any examination of indoor comfort. Various solutions are available in order to achieve optimum acoustic comfort. However, these are only helpful and effective if they take into account prevailing conditions, intended uses and scientific principles. It is particularly worthwhile to include the ceiling in the room acoustic concept. It should be ideally installed for sound absorption from a technical point of view, offer plenty of space and be capable of making a significant contribution to good room acoustics.

As a provider of radiant ceiling systems specialising in indoor comfort, we regard room acoustics as a significant comfort factor. Corresponding parameters for the different radiant ceiling systems are therefore available from certified test institutes for room acoustic planning.

 You can find more information in our document « Room acoustics in offices »



SCAN ME

U4X Hybrid system

Hybrid system with building mass connection

The U4X hybrid system is a multifunctional radiant ceiling system and is ideal for meeting the increasing demands of modern buildings. A special feature of the U4X is inclusion of the building mass through direct control of the concrete ceiling. This results in a mass storage capacity in addition to the usual water and air cooling capacity. This can significantly reduce operating costs and CO₂ emissions.

Thanks to its closed room design, the U4X hybrid system delivers good sound absorption values, particularly in the low frequency range.



Delivering enhanced wellbeing

The U4X radiant ceiling system is particularly suitable for offices, conference suites, hotels, schools and other commercial applications.

It not only ensures comfort, but also promotes productivity and the wellbeing of employees and customers.

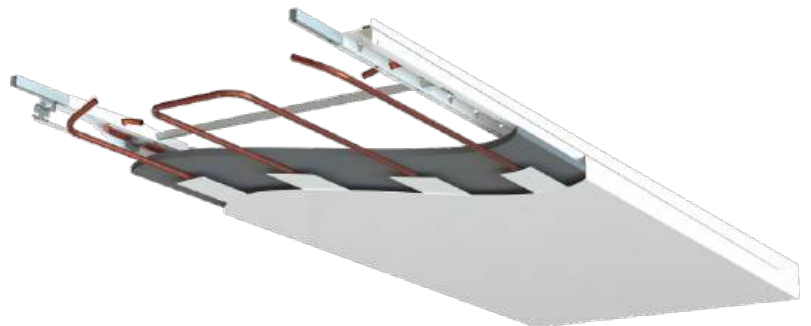



- ✓ Offices and commercial buildings
- ✓ Educational institutions
- ✓ Medical facilities
- ✓ Museums / theatres / cinemas

VARICOOL TKM Hybrid system

Sustainability meets design: This hybrid system is an innovative solution for modern architecture

The VARICOOL TKM jointless hybrid system is a water-based radiant ceiling system. In conjunction with the CAURUS hybrid system, it guarantees an optimum room climate in any environment. This combination has very high heating and cooling capacities, convenient supply air ducting and superior acoustic properties. In addition, the system incorporates the storage mass for dissipating heat loads into the overall room thermal concept using the thermally active building system principle. This further reduces energy requirements and operating costs.

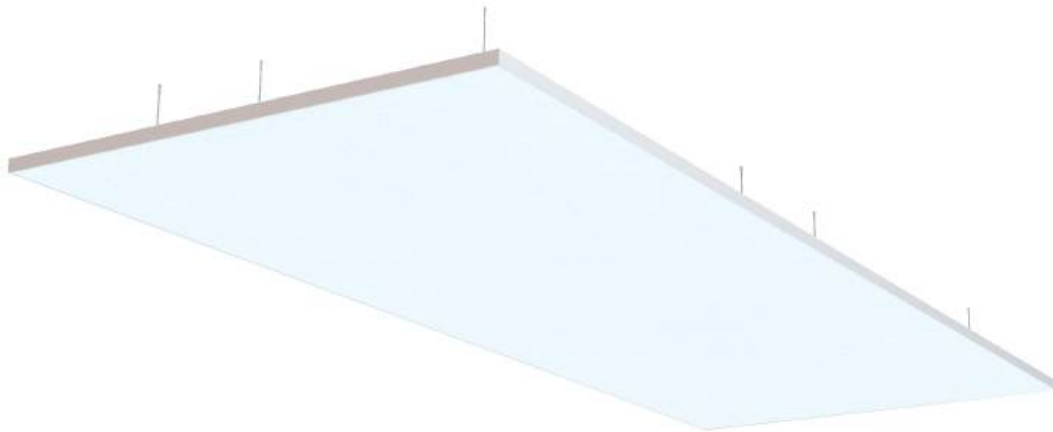

Efficient indoor air circulation with CAURUS

With supply air flow rates of up to $35 \text{ m}^3/\text{h} \cdot \text{linear metre}$ per sail, the supply air is introduced horizontally into the room on one side above the textile sail. Specially developed high capacity induction nozzles draw in warm room air on the opposite side of the sail and accelerate it via the supply air channel, thus achieving high energy transfer into the concrete. The energy temporarily stored in this way can be dissipated at night – with free cooling if possible. Due to the highly effective ventilation results, draught-free mixing of the air throughout the room with a homogeneous temperature profile is established within a very short time.

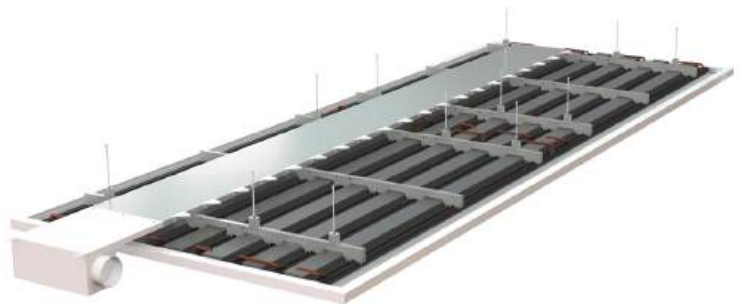



- ✓ Offices and commercial buildings
- ✓ Educational institutions
- ✓ Medical facilities
- ✓ Museums / theatres / cinemas

CAURUS Hybrid system

Hybrid system with building mass connection

Thanks to its comprehensive functionality, the CAURUS hybrid system with the A11-S or SPECTRA M-S radiant ceiling sails achieves an optimum room climate in any environment. This combination has very high heating and cooling capacities, convenient supply air ducting and very good acoustic properties.

Using the thermally active building system principle, this radiant ceiling system incorporates the storage mass for dissipating heating loads into the overall room thermal concept. This can significantly reduce operating costs and CO₂ emissions.

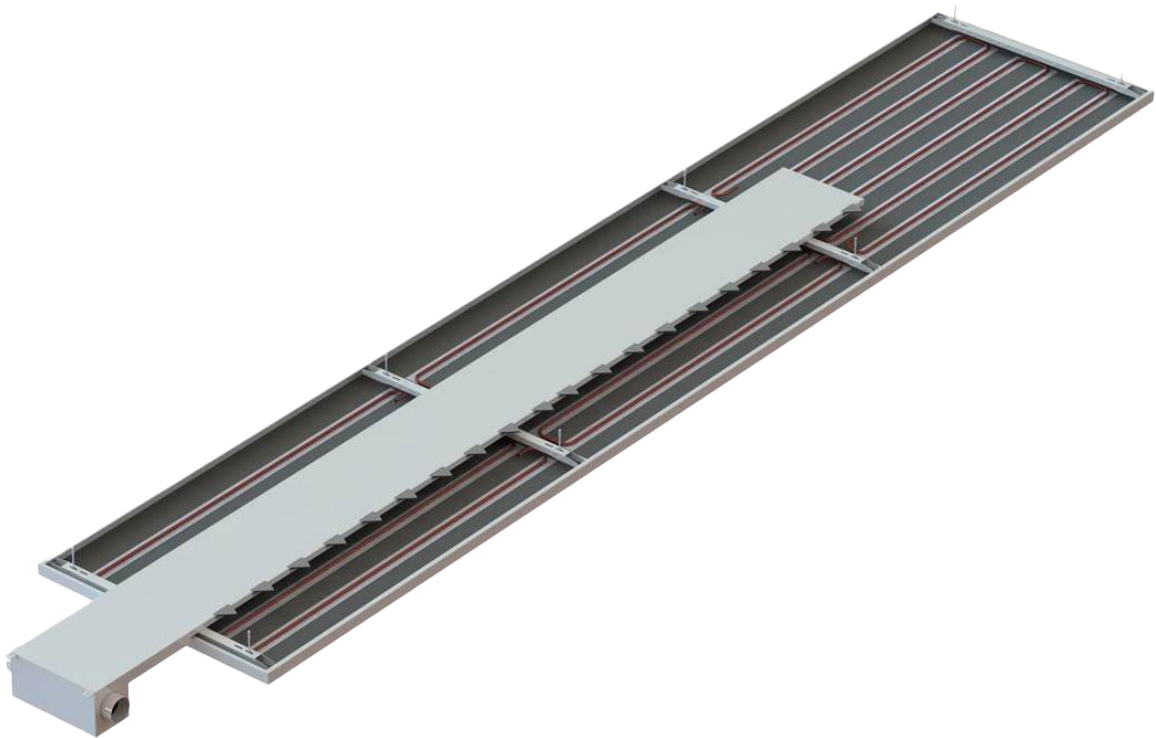

Optional added performance: CAURUS + Convector Wings

A further increase in performance can be achieved with the Convector Wings developed and patented by Barcol-Air.

Convector Wings are matt black anodised aluminium profiles with upright and slotted "wings" on both sides. With the profile open at the bottom, the Convector Wings can be attached to the straight sections of a pipe meander. This multiplies the heat exchanger surface area, which in turn leads to an increase of capacity on the water side.

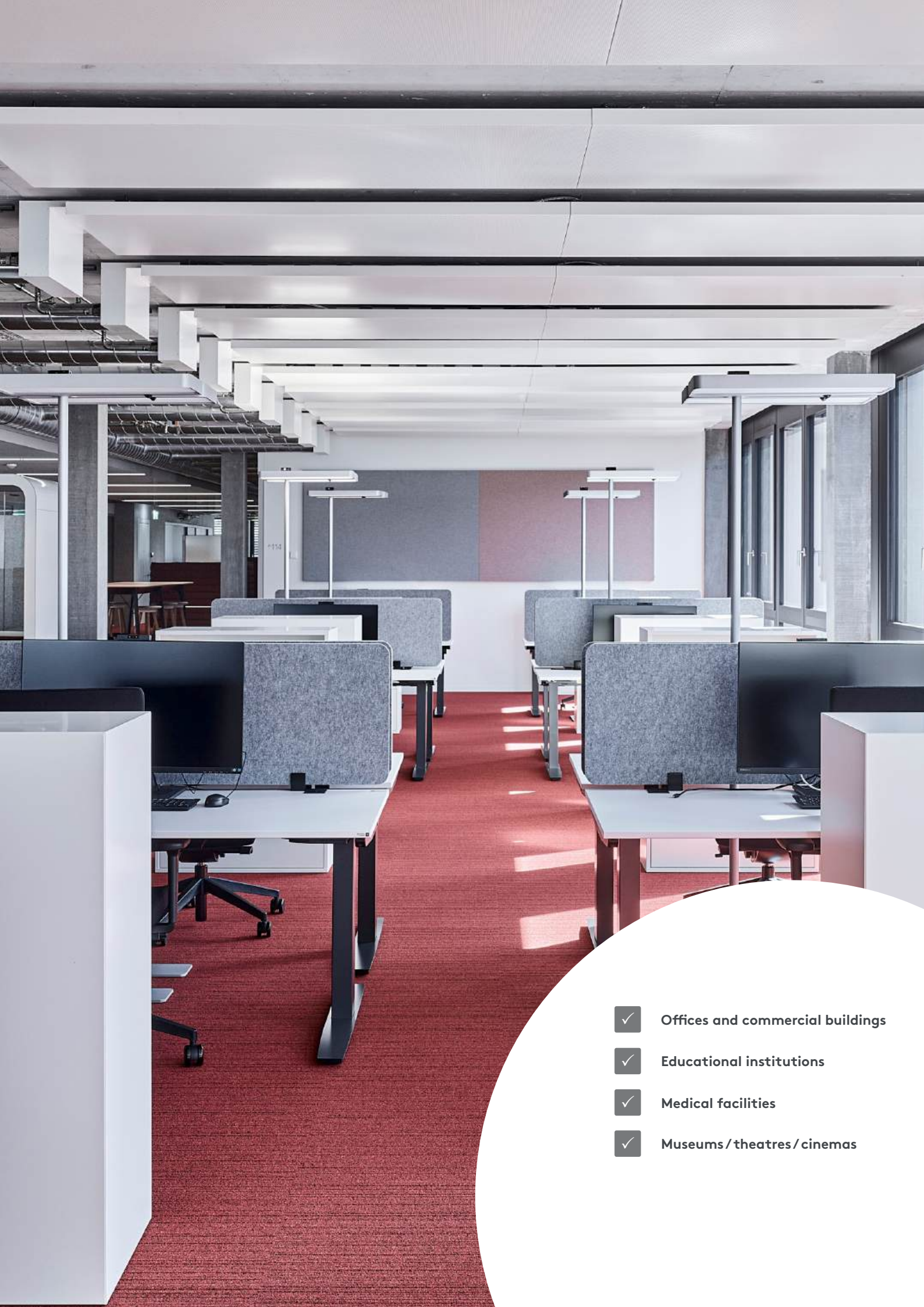

- ✓ Offices and commercial buildings
- ✓ Educational institutions
- ✓ Medical facilities
- ✓ Museums / theatres / cinemas

AQUILO Hybrid system

Hybrid system with building mass connection

AQUILO + the A11 or SPECTRA M radiant ceiling system are highly efficient radiant ceiling systems with integrated supply air and superior acoustic effectiveness. The AQUILO hybrid system delivers highly effective ventilation results. At the same time, the supply air jet on the back of the ceiling panel increases the convective capacity, which supports the heating and cooling effect in the room without a risk of draughts.

The AQUILO hybrid system with A11-C and SPECTRA M-C ceilings incorporate the storage mass for dissipating heating loads using the thermally active building system principle.

The A11-S sail allows the use of our specially developed Convector Wings to increase performance.

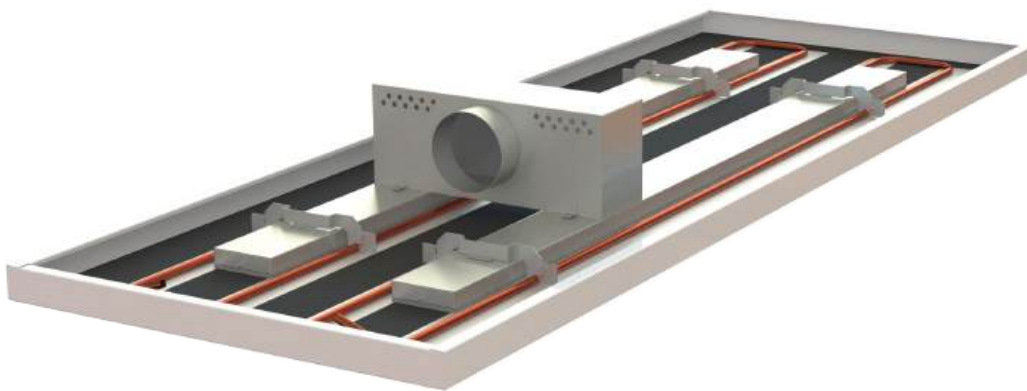

3-channel type AQUILO with supply air flow characteristics.

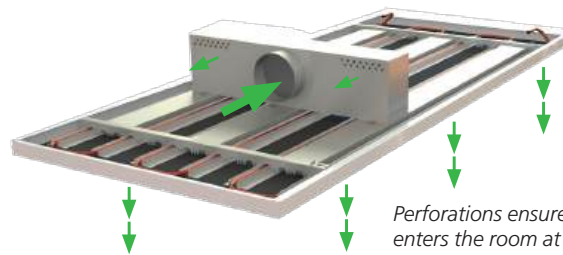

Perforations ensure that the supply air enters the room at low velocity

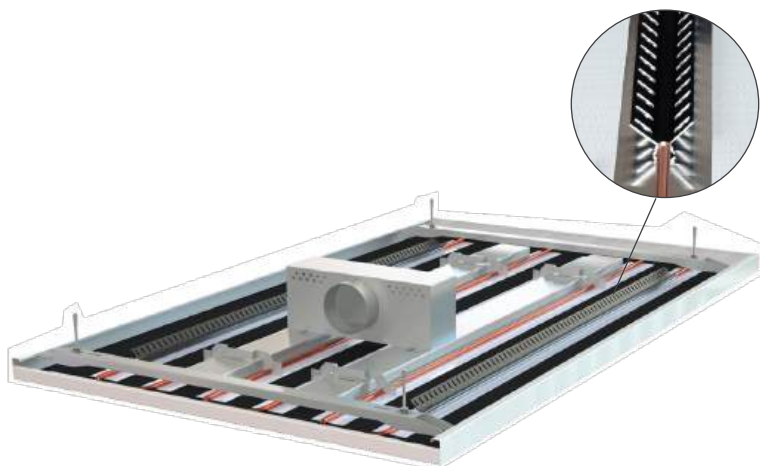

Activated A11-S ceiling panels are suitable for use with Convector Wings.

Optional added performance: AQUILO + Convector Wings

Convector Wings are matt black anodised aluminium profiles with upright and slotted "wings" on both sides. With the profile open at the bottom, the Convector Wings can be attached to the straight sections of a pipe meander. This multiplies the heat exchanger surface area, which in turn leads to an increase of capacity on the water side.



- ✓ Offices and commercial buildings
- ✓ Educational institutions
- ✓ Medical facilities

VENTAMIC Hybrid system

Hybrid system with building mass connection

VENTAMIC + the radiant metal ceiling A11-C or SPECTRA M-C are highly efficient ceiling system with integrated supply air and superior acoustic effectiveness. The VENTAMIC hybrid system delivers highly effective ventilation results. The air speed in occupied areas remains extremely low thanks to the Coanda effect.

The supply air jet generates negative pressure in the ceiling cavity, which increases the convective capacity and significantly heightens the heating and cooling effect of the water-based radiant ceiling. Furthermore, this system is using the building mass to store energy temporarily. With this function, the heat-load peaks can be broken down. The system works according to the principle of thermally active building systems.

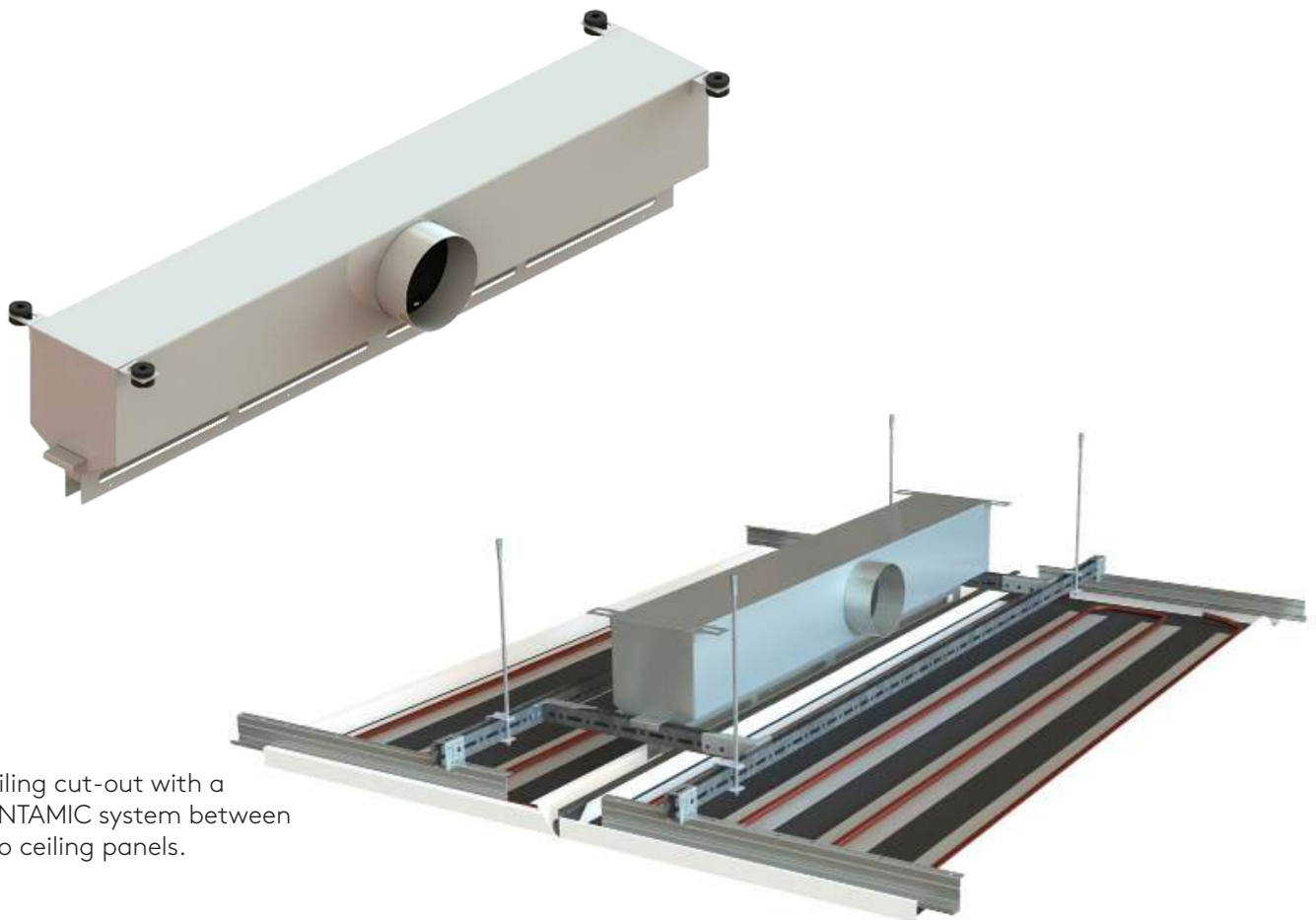

Ceiling cut-out with a VENTAMIC system between two ceiling panels.

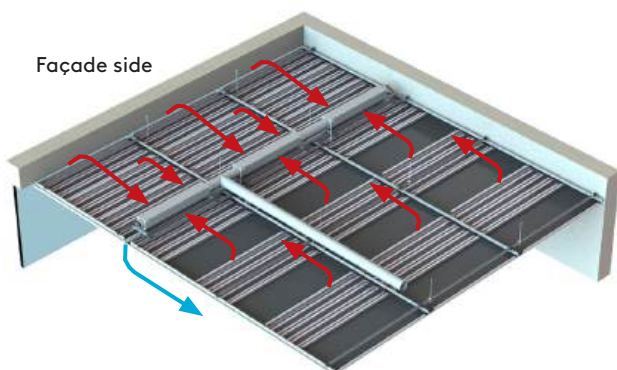

Façade side

Flow characteristics of the supply air

The supply air jet generates negative pressure in the ceiling cavity, which draws warm air from the room through the joints on the façade side and between the ceiling panels, and returns it to the room cooled by the recirculation effect.



- ✓ **Offices and commercial buildings**
- ✓ **Educational institutions**
- ✓ **Medical facilities**
- ✓ **Museums / theatres / cinemas**

A11-S Radiant ceiling sail

The slimline high performance sail

The A11-S radiant ceiling sail is a highly efficient radiant ceiling system that receives a flow of room air on all sides. If a full-surface insulation insert is not installed, the back of the sail can also actively contribute to room cooling.

The innovative A11 activation system has a special structure. The copper pipe and aluminium heat conducting rails are welded together using laser technology. The coils are permanently bonded to the metal plates using a special adhesive and high pressure, thereby ensuring optimum thermal transfer. Aluminium panels can also be activated using the adhesive technology, which results in further improvements in performance.

In order to satisfy the acoustic requirements, acoustic fleece is bonded in the back of the ceiling panels. In particularly sensitive areas, additional insulation strips can be inserted at the side of the coil to increase sound absorption without reducing the cooling capacity.

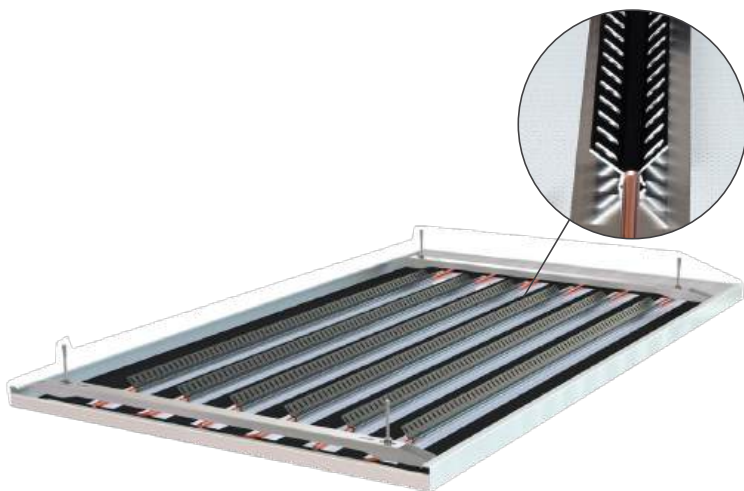
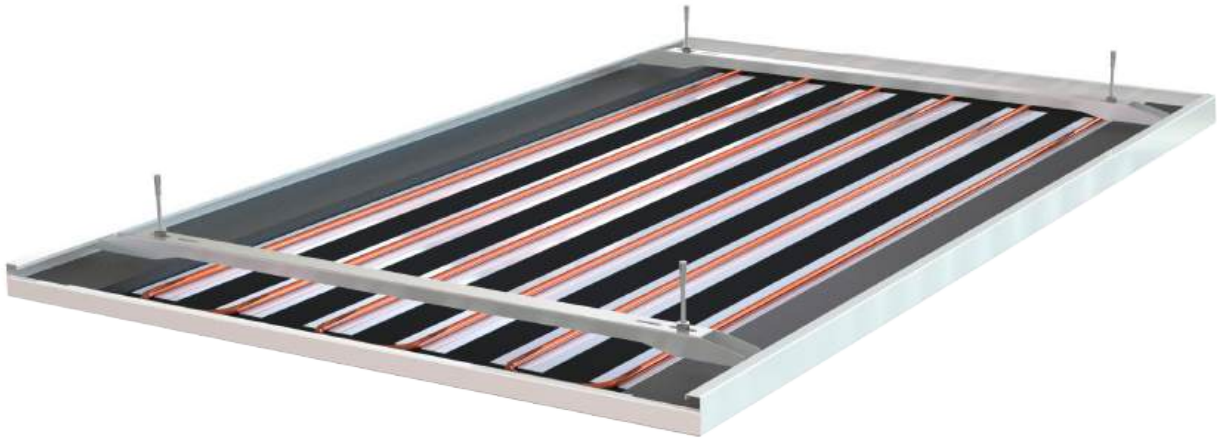

Optional added performance: A11-S + Convector Wings

A further increase in performance can be achieved with the Convector Wings developed and patented by Barcol-Air.

Convector Wings are matt black anodised aluminium profiles with upright and slotted “wings” on both sides. With the profile open at the bottom, the Convector Wings can be attached to the straight sections of a pipe meander. This multiplies the heat exchanger surface area, which in turn leads to an increase of capacity on the water side.



- ✓ Offices and commercial buildings
- ✓ Educational institutions
- ✓ Medical facilities
- ✓ Museums / theatres / cinemas

SPECTRA M-S Radiant ceiling sail

A unique radiant ceiling system with magnetic force

The SPECTRA M-S radiant sail is a highly efficient radiant ceiling system with superior acoustic effectiveness. The magnetic connection of the activation coil and ceiling panel allows both components to be prefabricated concurrently and delivered separately to the construction site for assembly there.

The SPECTRA M coil is ideal for refurbishing buildings in which existing metal ceilings are to be activated at a later stage. Furthermore, the coils can be fitted and hydraulically connected independently of the ceiling panels, meaning that the cooling technology can be installed and commissioned before the surface is finished. This also enables operation of the coils in advance for construction heating.

In order to satisfy the acoustic requirements, acoustic fleece is bonded in the back of the ceiling panels. In particularly sensitive areas, additional insulation strips can be inserted at the side of the coil to increase sound absorption without reducing the cooling capacity.

The design of the SPECTRA M coil also makes it possible to separate all components by material type for subsequent feeding into a recycling process. This contributes to a sustainable circular economy even after the useful life of the product has come to an end.



Impressive magnet technology

A further advantage of the system is that the magnet technology and U support rails used to secure the activation coils in place prevent the panels from sagging, even with larger panel formats.





- ✓ Offices and commercial buildings
- ✓ Educational institutions
- ✓ Medical facilities
- ✓ Museums / theatres / cinemas

AKUSTIKTHERM Radiant ceiling sail

For thermally active building systems (TABS)

AKUSTIKTHERM is an acoustically effective and thermally conductive ceiling sail system for use in properties with thermally active building systems (TABS). The acoustic sail transfers energy from the concrete surface into the room via heat radiation using an exchange system with a special coating, while at the same time providing expansive sound absorption surfaces.



Whether you want to improve the acoustics in an open-plan office, event room or restaurant, AKUSTIKTHERM is the ideal solution for creating a pleasant acoustic environment and increasing the productivity and satisfaction of your employees, customers or guests.

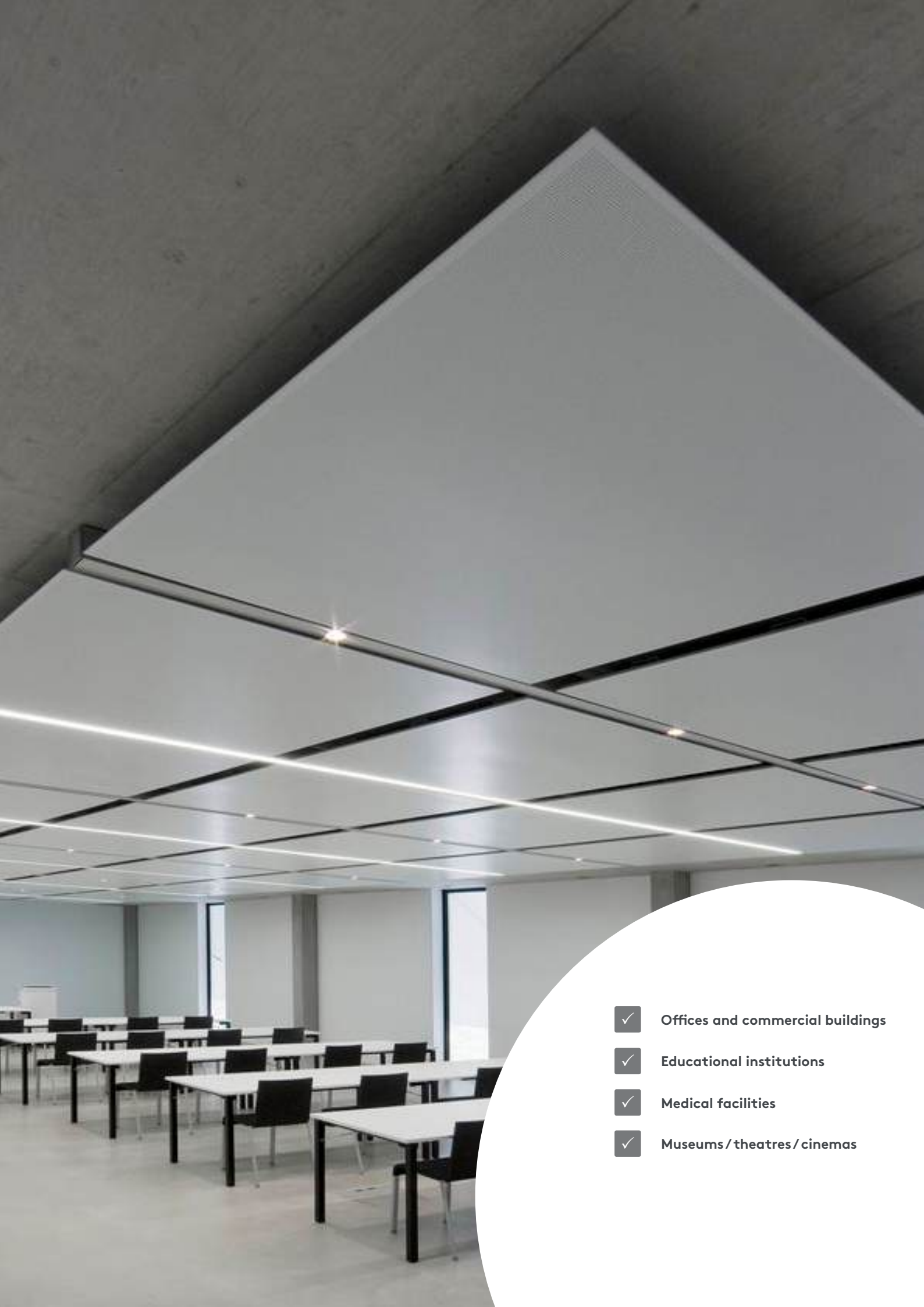

- ✓ Offices and commercial buildings
- ✓ Educational institutions
- ✓ Medical facilities
- ✓ Museums / theatres / cinemas

A11-C Radiant ceiling

Discreet yet striking radiant ceiling

The A11-C radiant metal ceiling delivers high thermal comfort in rooms with large heating loads, without causing draughts. The radiant ceiling system also exhibits advanced acoustic effectiveness.

The innovative A11 activation system has a special structure. The copper pipe and aluminium heat conducting rails are joined together using laser welding technology. The coils are permanently bonded to the metal plates using a special adhesive and high pressure, thereby ensuring optimum thermal transfer. Aluminium panels can also be activated using the adhesive technology, which results in further improvements in performance.

In particularly sensitive areas, additional insulation strips can be inserted to increase sound absorption without reducing the cooling capacity. A full-surface insulation layer is also possible.

The versatility of the product means that all standard installation methods and special solutions that are typical for metal ceilings can be used. This includes options such as C-Channel-, Hook-On- or Clip-In ceiling systems, which makes it easy to adapt to different room designs and architectural specifications.

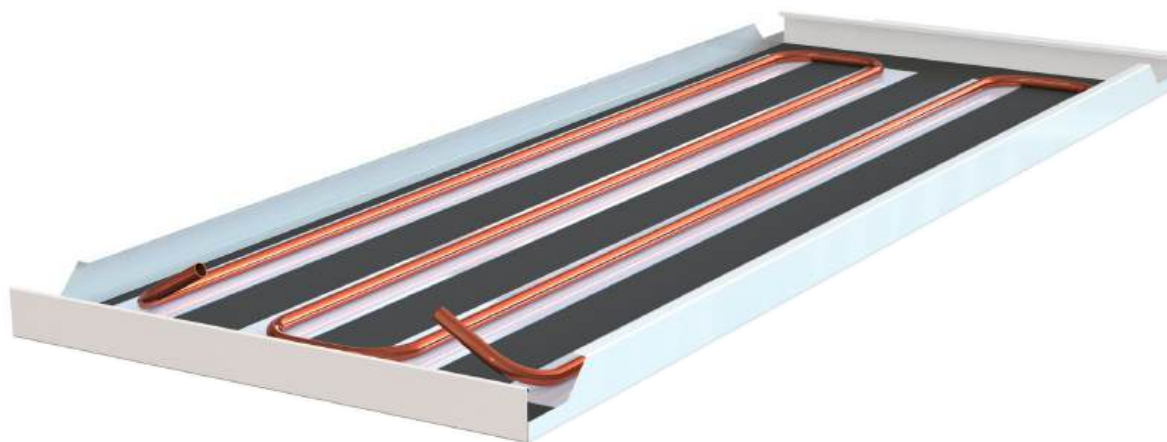



- ✓ Offices and commercial buildings
- ✓ Educational institutions
- ✓ Medical facilities
- ✓ Museums / theatres / cinemas

SPECTRA M-C Radiant ceiling

A unique radiant ceiling system with magnetic force

The SPECTRA M-C radiant ceiling is a water-based radiant ceiling system with high thermal and advanced acoustic effectiveness. The magnetic connection of the activation coil and ceiling panel allows both components to be prefabricated concurrently and delivered separately to the construction site for assembly there. As a result, the manufacturing time for the ceiling as a whole is significantly reduced.

The SPECTRA M coil is ideal for refurbishing buildings in which existing metal ceilings are to be activated at a later stage. Furthermore, the coils can be fitted and hydraulically connected independently of the ceiling panels, meaning that the cooling technology can be installed and commissioned before the surface is finished. This also enables operation of the coils in advance for structural heating.

In particularly sensitive areas, additional insulation strips can be inserted to increase sound absorption without reducing the cooling capacity. A full-surface insulation layer is also possible.

The design of the SPECTRA M coil also makes it possible to separate all components by material type for subsequent feeding into a recycling process. This contributes to a sustainable circular economy even after the useful life of the product has come to an end.



Impressive magnet technology

A further advantage of the system is that the magnet technology and U support rails used to secure the activation coils in place prevent the panels from sagging, even with larger panel formats.



- ✓ Offices and commercial buildings
- ✓ Educational institutions
- ✓ Medical facilities
- ✓ Museums / theatres / cinemas

VARICOOL UNI Radiant ceiling

Thermally active plasterboard ceiling

The jointless VARICOOL UNI radiant ceiling is suitable for properties in which a combination of aesthetics and thermal comfort is required. It is visually indistinguishable from a conventional drywall ceiling. Full-surface ceiling activation, installations and customised ceiling designs with 3D elements are all possible with this solution. VARICOOL UNI can also be used as a sail.

Perforated plasterboard panels with acoustic fleece applied to the back can be used to satisfy the acoustic requirements. An additional insulation layer can be provided in order to increase sound absorption in particularly sensitive areas.

The heating/cooling coils are adapted to the standard substructure and replace parts of it. The system is suitable for use with plasterboard, expanded glass granulate and aluminium honeycomb panels.

Optimum heat transfer

The panelling is bolted directly to the activation profiles. This ensures very good heat transfer and consistent quality.

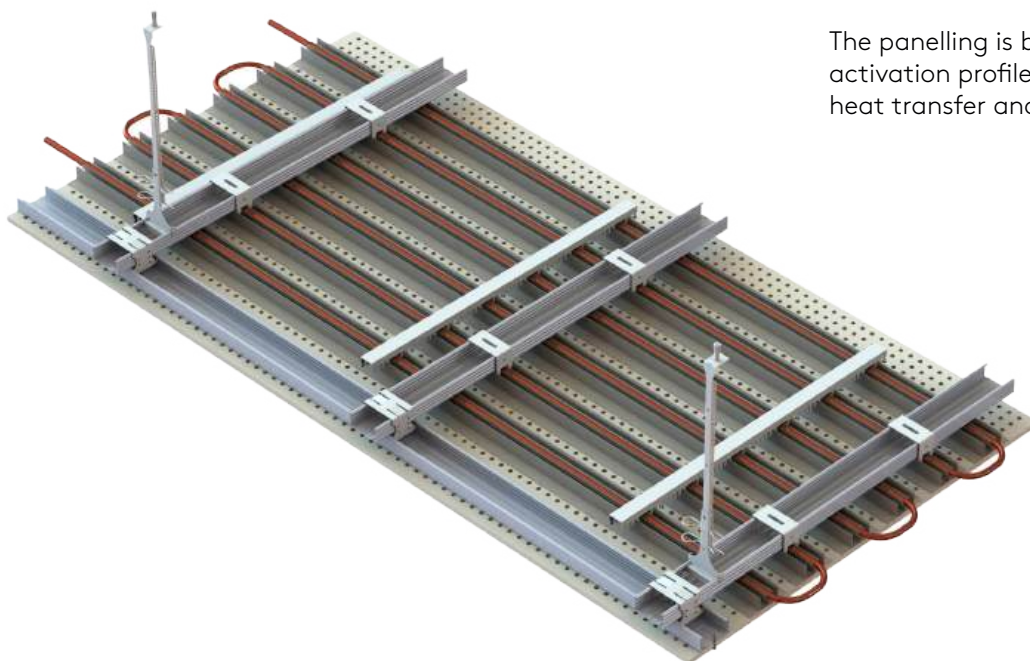



- ✓ Offices and commercial buildings
- ✓ Educational institutions
- ✓ Medical facilities
- ✓ Museums / theatres / cinemas

VARICOOL AP Radiant ceiling

Thermally active plasterboard ceiling

The jointless VARICOOL AP radiant ceiling is suitable for properties in which a combination of aesthetics and thermal comfort is required. It is visually indistinguishable from a conventional drywall ceiling. Full-surface ceiling activation, the flexible arrangements of profiles, installations and customised ceiling designs with 3D elements are all possible with this solution. VARICOOL AP can also be used as a sail.

Perforated plasterboard panels with acoustic fleece applied to the back can be used to satisfy the acoustic requirements. An additional insulation layer can be provided in order to increase sound absorption in particularly sensitive areas.

The activation profiles for jointless radiant ceilings are adapted to the standard substructure and replace parts of it. The system is suitable for use with plasterboard, expanded glass granulate and aluminium honeycomb panels.



Optimum heat transfer

The panelling is bolted directly to the activation profiles. This ensures very good heat transfer and consistent quality.

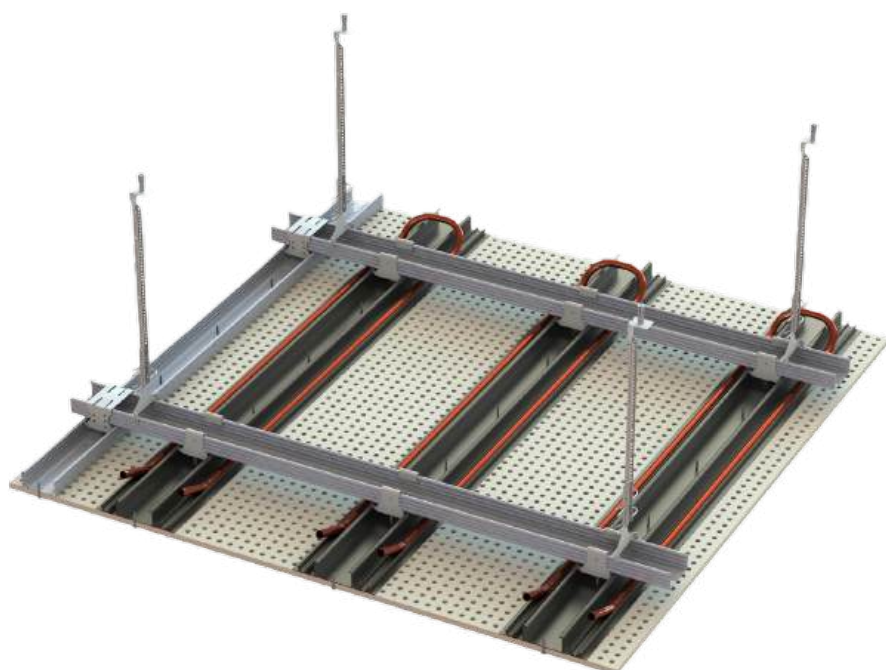



- ✓ Offices and commercial buildings
- ✓ Educational institutions
- ✓ Medical facilities
- ✓ Museums / theatres / cinemas

ARCHISONIC® Acoustic baffle

Unique room ambience with stylish design

ARCHISONIC® + the A11 radiant metal ceiling system or ALBATROS high performance module are visually and functionally impressive in equal measure. The system satisfies the requirements of a modern radiant ceiling when it comes to both energy efficiency and performance. The combination of the radiant ceiling system with the ARCHISONIC® acoustic baffle from Impact Acoustic® also forms a highly effective sound absorber across the entire frequency spectrum.

Whilst the felt panels (made from recycled PET bottles) primarily absorb sound in the high frequency range, the strength of the A11 radiant metal ceiling system lies in the low frequency range.

The combination solution can be used as an A11-C closed radiant ceiling system, A11-S sail or ALBATROS high performance module. The acoustic baffles are available in a wide range of colours and in the versions Straight, Wave or Edge. They are installed on site on the underside of the metal ceiling using a simple suspension method.

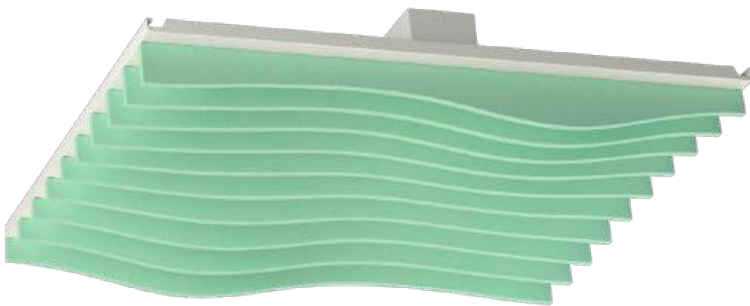

ARCHISONIC® Wave

ARCHISONIC® Straight

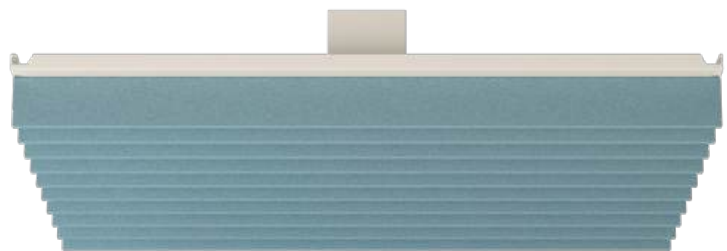

ARCHISONIC® Edge



- ✓ Offices and commercial buildings
- ✓ Museums / theatres / cinemas
- ✓ Restaurants and cafeterias

ALBATROS High performance module

High performance module for unbeatable cooling capacity

The ALBATROS high performance module is a radiant ceiling system for rooms with a high cooling demand. It achieves a very high thermal performance with its slotted aluminium fins in the shape of a wing.

Through optional combination with the sound absorber structure, the ALBATROS also demonstrates advanced acoustic effectiveness.

Another special feature is the high surface-related, predominantly convective cooling capacity. Combination with any air ducting system is also possible. The modular ceiling system is suitable for covering the heating demand as well.

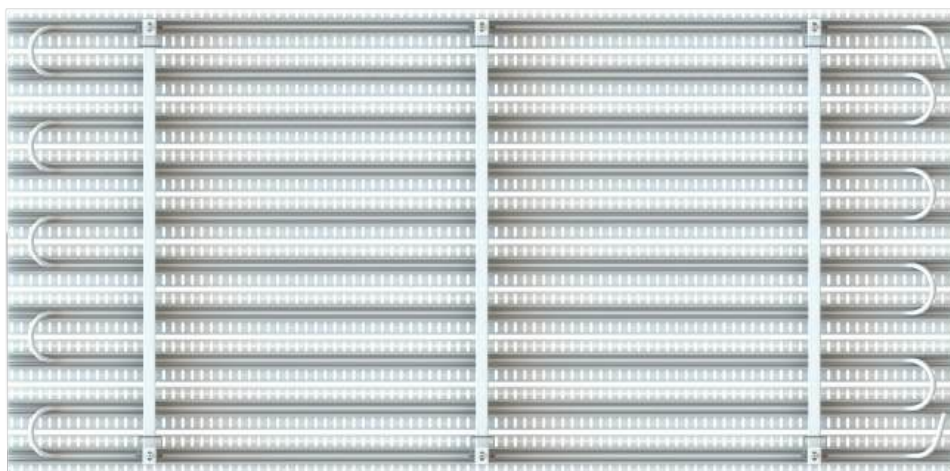
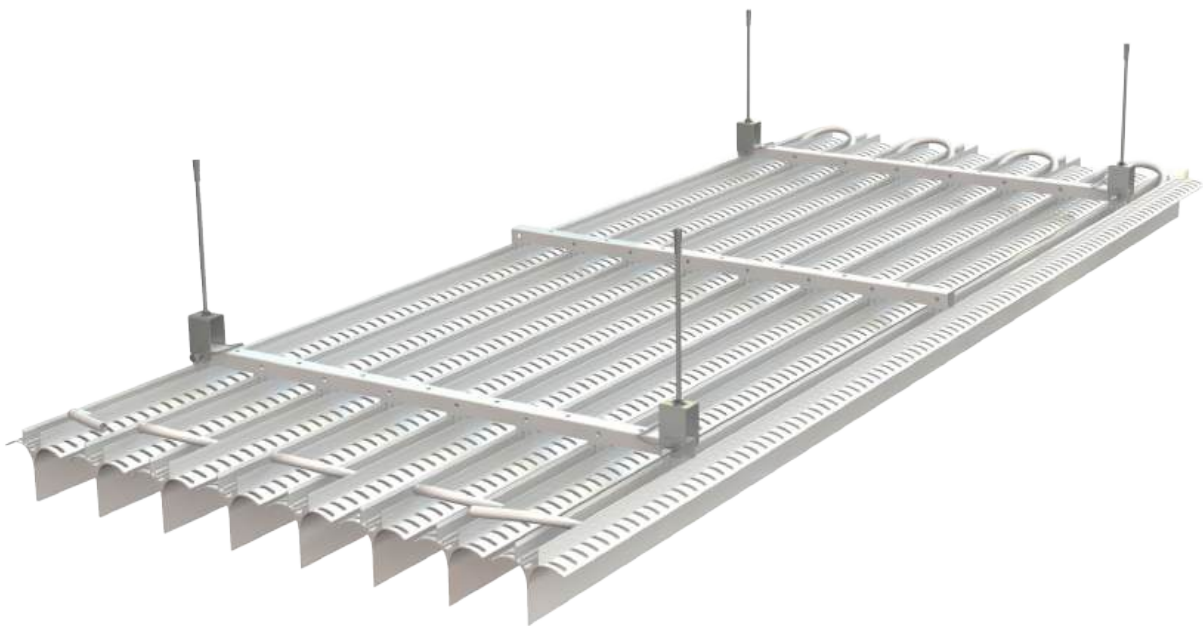



- ✓ Offices and commercial buildings
- ✓ Educational institutions
- ✓ Railway stations and airports
- ✓ Museums / theatres / cinemas

OPTI Y High performance module

High performance module with very high thermal capacity

OPTI Y is a high capacity cooling system with an open design for cooling rooms, predominantly through free convection and radiation. Equipped with a fine corrugated surface, the finned cooling elements are suitable for rooms of all types and can be used as individually suspended ceiling modules, a flat finned ceiling or in a concealed installation above a grid ceiling.

The high cooling capacity per unit area (mainly convective) and the large open ceiling cross-section are particular features. Sprinklers, smoke detectors, air diffusers, lighting fixtures, etc. can be installed between the fins.

It can be combined with any air ducting system. The OPTI Y high performance module can also cover the heating load.

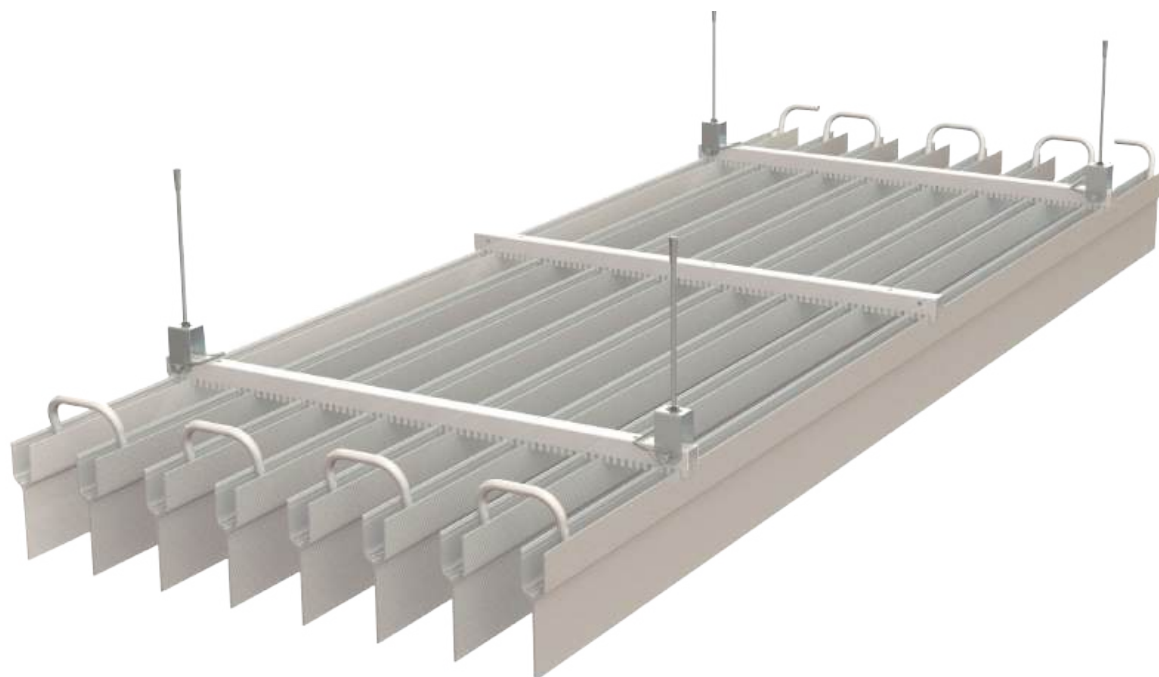
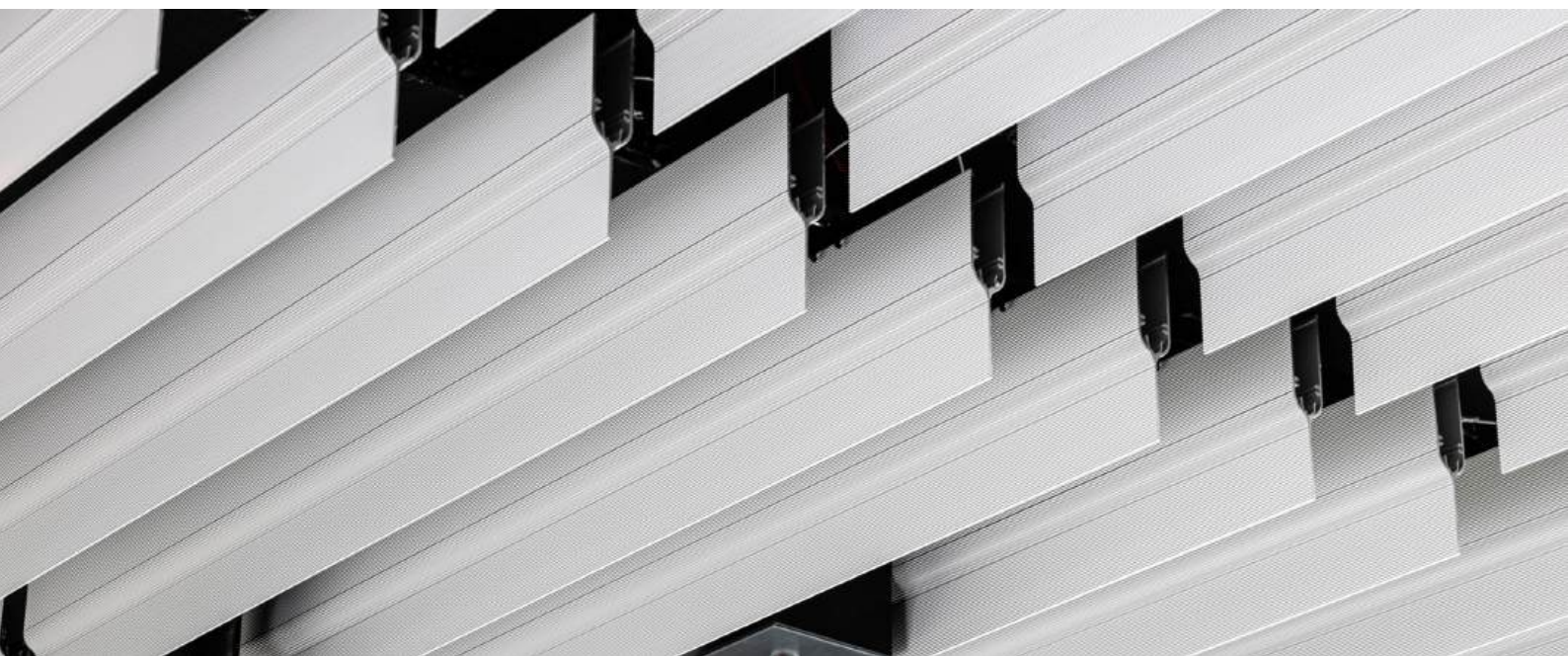



- ✓ Offices and commercial buildings
- ✓ Educational institutions
- ✓ Railway stations and airports
- ✓ Museums / theatres / cinemas

SOFTLINE High performance module

Aesthetic ceiling with high cooling capacity

SOFTLINE affords a wide range of installation options. With its sleek design, the ceiling fits perfectly in showrooms, offices and corridors. Lighting can be installed between the aluminium profiles or beneath the profiles in the form of pendant lights.

The SOFTLINE high performance modules are available as Base, Roof and Curve versions and offers maximum flexibility to adapt to different architectural and aesthetic requirements.



SOFTLINE Base



SOFTLINE Roof



SOFTLINE Curve



- ✓ Offices and commercial buildings
- ✓ Educational institutions
- ✓ Railway stations and airports
- ✓ Museums / theatres / cinemas

METAL LINE Radiant Baffle

Efficient and flexible high performance module

The METAL LINE radiant baffles are an efficient radiant ceiling system with good sound absorption properties. The vertical arrangement results in a comparatively high proportion of surface area with thermally and acoustically effective metal baffles.

Furthermore, the quick and easy installation means retrofitting in existing buildings is straightforward and does not affect ongoing use. The METAL LINE radiant fins therefore offer an efficient, flexible and aesthetically pleasing solution for a pleasant room climate and an improved room acoustic concept.

In order to satisfy the acoustic requirements, acoustic fleece is bonded inside the radiant fins. An additional insulation insert can be provided in order to increase sound absorption in particularly sensitive areas.

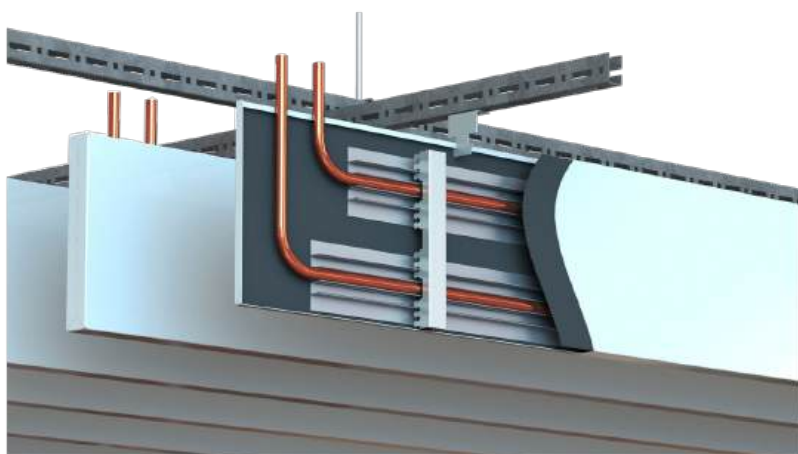
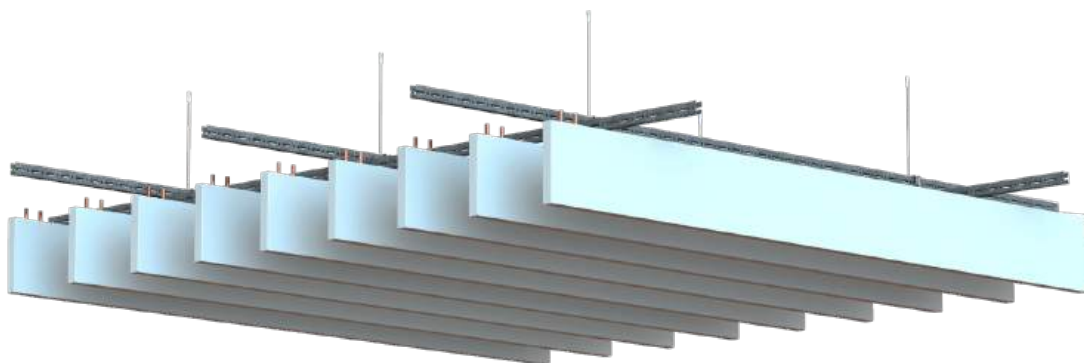

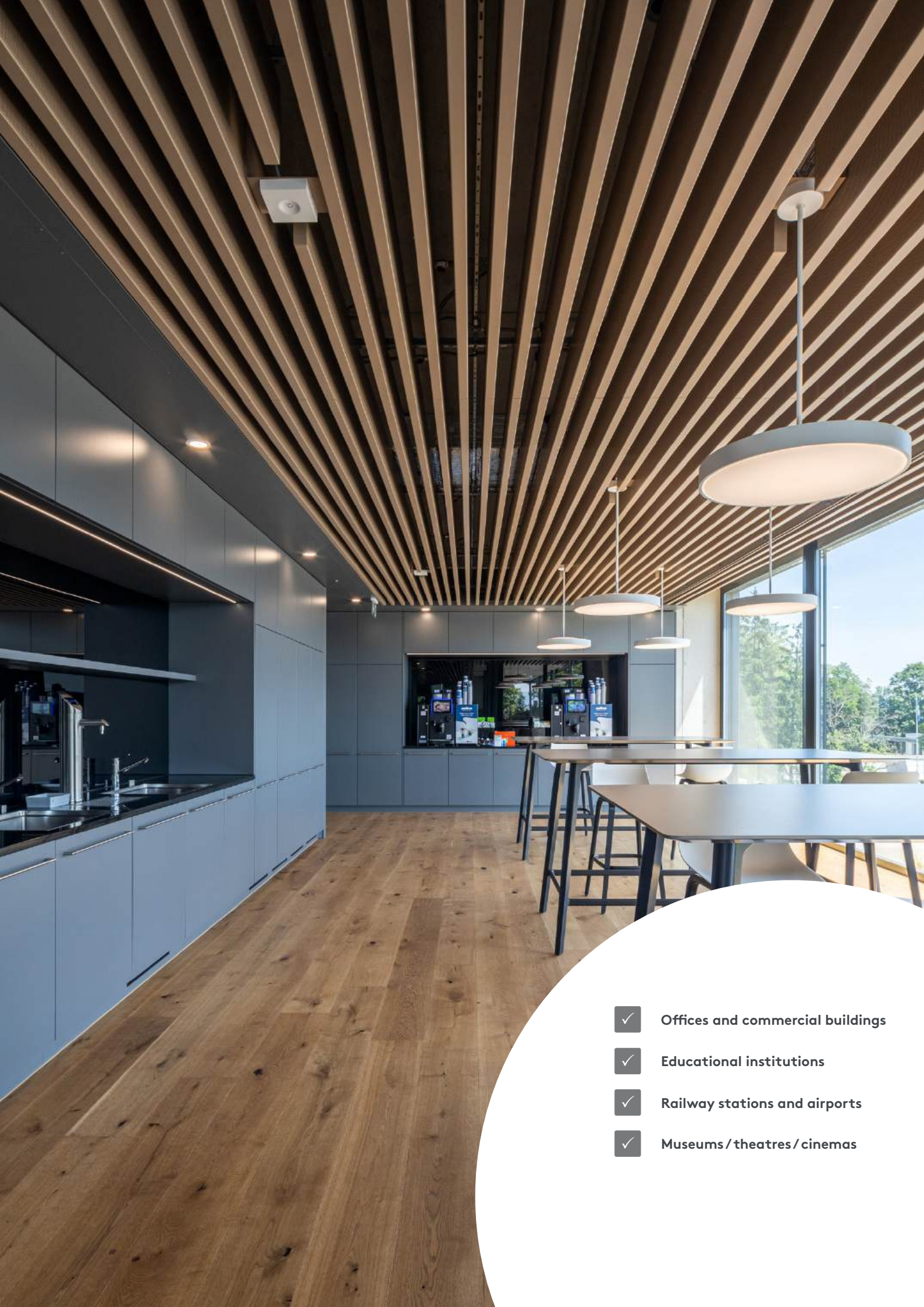

- ✓ Offices and commercial buildings
- ✓ Educational institutions
- ✓ Railway stations and airports
- ✓ Museums / theatres / cinemas

U4X

Hybrid system with building mass connection

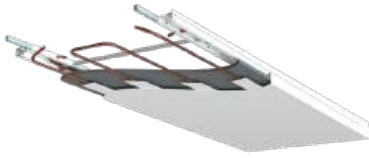

- Very high heating & cooling capacity
- Superior sound absorption values (class A)
- Lower energy consumption thanks to active building mass connection
- Covers cooling requirements with free cooling 75-85 % of the time
- Components can be integrated

Dimensions:

Installation height: 75 mm

- Panel length: 800 – 3000 mm
- Panel width: 400 – 1200 mm
- Panel height: 50 – 100 mm

Custom dimensions on request

Water capacity: *

Cooling: up to 87 W/m² (ΔT: 8 K)
at 85 % Aar

+ mass storage capacity:
up to 25 W/m² panel area

Heating: up to 125 W/m² (ΔT: 15 K)



VARICOOL TKM

Textile hybrid system with building mass connection



- In combination with CAURUS
- Very high heating & cooling capacity
- Advanced sound absorption values (class B)
- Building mass connection
- Fresh air intake is silent and draught-free
- Components can be integrated

Dimensions:

Installation height: 180 – 500 mm

- Textile length: 1040 mm – 50 m
- Textile width: 740 – 4940 mm
- System height: 137 mm

Custom dimensions on request

Water capacity: *

Cooling: up to 95 W/m² (ΔT: 8 K)

Heating: up to 103 W/m² (ΔT: 15 K)



CAURUS

Hybrid system with building mass connection



- In combination with A11-S, SPECTRA M-S, VARICOOL TKM
- Very high heating & cooling capacity
- Superior sound absorption values (class A)
- Building mass connection
- Integrated cross-talk sound attenuation (option)
- Low structural height
- Sound power level L_w: < 30 dB (A)
- Fresh air intake is silent and draught-free

Dimensions:

Installation height: 80 – 200 mm

- Panel length: 800 – 3000 mm
- Panel width: 400 – 1200 mm
- Panel height: 30 – 50 mm

Custom dimensions on request

Water capacity: *

Mass storage capacity:
up to 20 W/m² panel area

A11-S, SPECTRA M-S

Cooling: up to 125 W/m² (ΔT: 8 K)
at 85 % Aar

Heating: up to 117 W/m² (ΔT: 15 K)

With flowing supply air, there will be a 20 to 40 % higher heating capacity.



* Cooling capacity based on DIN EN 14240/heating capacity based on DIN EN 14037 : 2016
Higher capacities possible on a project-specific basis. Aar = Active area ratio.

AQUILO

Hybrid system with building mass connection

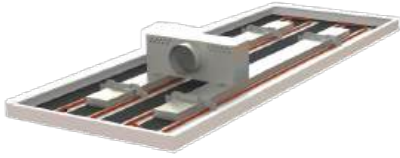

- In combination with A11-S, A11-C, SPECTRA M-S, SPECTRA M-C
- Very high heating & cooling capacity
- Superior sound absorption values (class A)
- Building mass connection (A11-C, SPECTRA M-C)
- Sound power level L_w : < 25 dB (A)
- Fresh air intake is silent and draught-free thanks to ceiling panel perforations

Dimensions:

Installation height: 150 – 220 mm

- Panel length: 800 – 3000 mm
- Panel width: 400 – 1200 mm
- Panel height: 30 – 50 mm

Custom dimensions on request

Water capacity: *

Mass storage capacity:

Sail up to 10 W/m² panel area

Closed ceiling: up to 5 W/m² panel area

A11-S, SPECTRA M-S

Cooling: up to 122 W/m² (ΔT : 8 K)
at 85 % Aar

Heating: up to 138 W/m² (ΔT : 15 K)

A11-C, SPECTRA M-C

Cooling: up to 114 W/m² (ΔT : 8 K)
at 75 % Aar

Heating: up to 113 W/m² (ΔT : 15 K)



VENTAMIC

Hybrid system with building mass connection



- In combination with A11-C, SPECTRA M-C
- Very high heating & cooling capacity
- Superior sound absorption values (class A)
- Building mass connection
- Sound power level L_w : < 35 dB (A)
- Fresh air intake is silent and draught-free

Dimensions:

Installation height: min. 250 mm

- Panel length: 600 – 3000 mm
- Panel width: 400 – 1200 mm
- Panel height: 40 mm

Custom dimensions on request

Water capacity: *

Mass storage capacity:

up to 10 W/m² panel area

A11-C, SPECTRA M-C

Cooling: up to 119 W/m² (ΔT : 8 K)
at 75 % Aar

Heating: up to 104 W/m² (ΔT : 15 K)



* Cooling capacity based on DIN EN 14240/heating capacity based on DIN EN 14037 : 2016
Higher capacities possible on a project-specific basis. Aar = Active area ratio.

Subject to technical changes.

A11-S

Radiant metal ceiling sail



- Very high heating & cooling capacity
- Superior sound absorption values (class A)
- Easy installation
- Low system weight
- Variable coil design
- Components can be integrated
- Can be combined with ARCHISONIC®, AQUILO, CAURUS

Dimensions:

Installation height: min. 80 mm

- Panel length: 800 – 3000 mm
- Panel width: 400 – 1200 mm
- Panel height: 30 – 50 mm

Custom dimensions on request

Water capacity: *

Cooling: up to 105 W/m² (ΔT: 8 K)
at 85 % Aar

Heating: up to 117 W/m² (ΔT: 15 K)

With Convector Wings:

Cooling: up to 122 W/m² (ΔT: 8 K)
at 85 % Aar

Heating: up to 117 W/m² (ΔT: 15 K)



SPECTRA M-S

Radiant metal ceiling sail with magnet technology

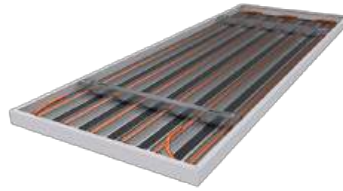

- Very high heating & cooling capacity
- Superior sound absorption values (class A)
- Ceiling panels and activation coils are connected using magnetic technology
- Tool-free fitting and removal of the coils
- Fully recyclable by material type
- Components can be integrated
- Can be combined with AQUILO, CAURUS

Dimensions:

Installation height: min. 80 mm

- Panel length: 800 – 3000 mm
- Panel width: 400 – 1200 mm
- Panel height: 30 – 40 mm

Custom dimensions on request

Water capacity: *

Cooling: up to 91 W/m² (ΔT: 8 K)
at 85 % Aar

Heating: up to 102 W/m² (ΔT: 15 K)



AKUSTIKTHERM

For thermal active building systems (TABS)



- For buildings with component activation (TABS)
- Superior sound absorption values (class A)
- Very low influence on the thermally active building system during cooling/heating
- Low installation height
- No maintenance required
- Product components can be recycled
- Components can be integrated

Dimensions:

Installation height: 60 – 500 mm

- Panel length: 800 – 3000 mm
- Panel width: 400 – 1200 mm
- Panel height: 30 – 50 mm

Custom dimensions on request

Energy transfer TABS

90 - 94 %



* Cooling capacity according to DIN EN 14240/heating capacity according to DIN EN 14037 : 2016
Higher capacities possible on a project-specific basis. Aar = Active area ratio.



A11-C

Radiant metal ceiling

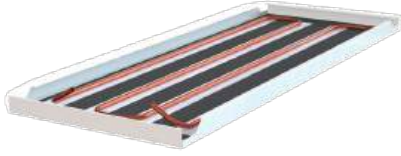

- Very high heating & cooling capacity
- Advanced sound absorption values (class B)
- Can be combined with all common metal ceiling systems
- Low system weight
- High thermal comfort in rooms with large heating loads
- Components can be integrated
- Can be combined with VENTAMIC, AQUILO, ARCHISONIC®

Dimensions:

Installation height: min. 100 mm

- Panel length: 600–3000 mm
- Panel width: 400–1200 mm
- Panel height: 30–50 mm

Custom dimensions on request

Water capacity: *

Cooling: up to 100 W/m² (ΔT: 8 K)
at 75 % Aar

Heating: up to 116 W/m² (ΔT: 15 K)



SPECTRA M-C

Radiant metal ceiling with magnetic technology



- High heating & cooling capacity
- Advanced sound absorption values (class B)
- Ceiling panels and activation coils are connected using magnetic technology
- Tool-free fitting and removal of the coils
- Fully recyclable by material type
- Existing metal ceilings can be retrofitted with the SPECTRA M magnetic system
- Components can be integrated
- Can be combined with AQUILO, VENTAMIC

Dimensions:

Installation height: min. 100 mm

- Panel length: 600–3000 mm
- Panel width: 400–1200 mm
- Panel height: 30–40 mm

Custom dimensions on request

Water capacity: *

Cooling: up to 83 W/m² (ΔT: 8 K)
at 75 % Aar

Heating: up to 87 W/m² (ΔT: 15 K)



VARICOOL UNI

Jointless radiant ceiling

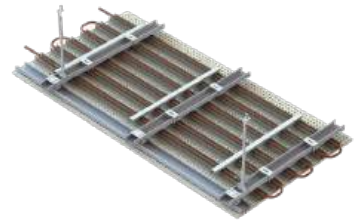

- High heating & cooling capacity
- Acoustically effective (class C)
- Can be used as a closed radiant ceiling or sail
- Coils are easy to install
- Coils replace parts of the substructure
- Full-surface ceiling activation possible
- Components can be integrated

Register dimensions:

Installation height: min. 120 mm

- Register length: 500–2500 mm
- Register width: 180–1000 mm
- Register height: 27 mm

Custom dimensions on request

Water capacity: *

Cooling: up to 77 W/m² (ΔT: 8 K)
at 65 % Aar

Heating: up to 103 W/m² (ΔT: 15 K)



* Cooling capacity according to DIN EN 14240/heating capacity according to DIN EN 14037 : 2016
Higher capacities possible on a project-specific basis. Aar = Active area ratio.

VARICOOL AP

Jointless radiant ceiling



- High heating & cooling capacity
- Acoustically effective (class C)
- Can be used as a closed radiant ceiling or sail
- Activation profiles are easy to install
- Profiles replace parts of the substructure
- Flexible profile arrangements possible
- Components can be integrated

Profile dimensions:

Installation height: min. 120 mm

- Profile length: 1000 – 3000 mm
- Profile width: 135 mm
- Profile height: 27 mm

Custom dimensions on request

Water capacity: *

Cooling: up to 82 W/m² (ΔT : 8 K) alu
at 85 % Aar

Heating: up to 118 W/m² (ΔT : 15 K) alu

Cooling: up to 67 W/m² (ΔT : 8 K) plaster
at 85 % Aar

Heating: up to 104 W/m² (ΔT : 15 K) plaster



ARCHISONIC®

Acoustic baffle



- In combination with A11-S, A11-C, ALBATROS
- High to very high heating & cooling capacity
- Superior sound absorption values (class A)
- Sustainable and high quality acoustic material made from PET
- Quick and easy installation
- Versions: Edge, Straight & Wave
- 28 different colours to choose from
- Components can be integrated

Baffle dimensions:

Installation height: min. 250 mm

- Baffle length: 400 – 1800 mm
- Baffle width: 24 mm
(28 PET bottles/m²)
- Baffle height: 150 mm

Custom dimensions on request

Water capacity:*

Cooling: up to 70 W/m² (ΔT : 8 K) A11-S

Heating: up to 90 W/m² (ΔT : 15 K) A11-S

Cooling: up to 60 W/m² (ΔT : 8 K) A11-C

Heating: up to 80 W/m² (ΔT : 15 K) A11-C

Cooling: up to 177 W/m² (ΔT : 8 K) ALBATROS

Heating: up to 234 W/m² (ΔT : 15 K) ALBATROS



* Cooling capacity according to DIN EN 14240 / heating capacity according to DIN EN 14037 : Higher capacities possible on a project-specific basis. Aar = Active area ratio. Subject to technical changes.

ALBATROS

High performance module



- Very high heating & cooling capacity
- With optional absorbers: Superior sound absorption values (class A)
- Powerful and energy efficient
- Exceptional design/performance concept
- Easy installation
- Anodised profiles available
- Components can be integrated
- Can be combined with ARCHISONIC®

Dimensions:

Installation height: min. 220 mm

- Module length: 600–2500 mm
- Module width: 290–990 mm
- Module height: 150 mm
- Pipe rows: 3–10
- Pipe spacing: 100 mm

Custom dimensions on request

Water capacity: *

Cooling: up to 241 W/m² (ΔT: 8 K)

Heating: up to 303 W/m² (ΔT: 15 K)



OPTI Y

High performance module

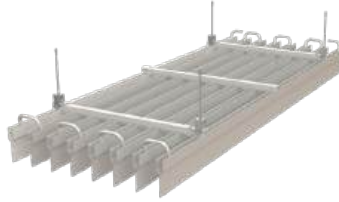

- Very high heating & cooling capacity
- With optional absorbers: Superior sound absorption values (class A)
- Powerful and energy efficient
- Can be combined with any ventilation system
- Easy installation
- Visible or concealed installation possible depending on visual requirements
- Anodised profiles available
- Components can be integrated

Dimensions:

Installation height: min. 250 mm

- Module length: 600–2500 mm
- Module width: 230–1080 mm
- Module height: 170 mm
- Pipe rows: 3–10
- Pipe spacing: 100/150 mm

Custom dimensions on request

Water capacity: *

Cooling: up to 198 W/m² (ΔT: 8 K)

Heating: up to 230 W/m² (ΔT: 15 K)



SOFTLINE

High performance module



- Very high heating & cooling capacity
- With optional absorbers: Advanced sound absorption values (class B)
- Powerful and energy efficient
- Simple installation; option to pivot modules down
- Versions: Curve, Roof & Base (others available on request)
- Anodised profiles available
- Components can be integrated

Dimensions:

Installation height: min. 180 mm

- Module length: 600–2500 mm
- Module width: 380–1290 mm
- Module height: 40 mm (Base)
50 mm (Roof, Curve)
- Pipe rows: 3–10
- Pipe spacing: 130 mm

Custom dimensions on request

Water capacity: *

Cooling: up to 142 W/m² (ΔT: 8 K)

Heating: up to 135 W/m² (ΔT: 15 K)



* Cooling capacity according to DIN EN 14240/heating capacity according to DIN EN 14037 : 2016
Higher capacities possible on a project-specific basis

METAL LINE

Radiant baffle

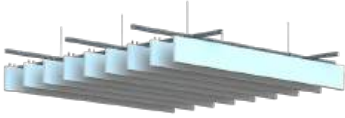

- Very high heating & cooling capacity
- Acoustically effective (class C)
- Quick and easy installation
- Suitable for retrofitting
- Available in various designs (colours, wood appearance, etc.)
- Components can be integrated

Dimensions:

Installation height: min. 260 mm

- Baffle length: 500 – 2500 mm
- Baffle width: 30/40 mm
- Baffle height: 200 mm

Custom dimensions on request

Water capacity: *

Cooling: up to 22 W/lm (ΔT : 8 K)
at 90 % Aar

Heating: up to 25 W/lm (ΔT : 15 K)



* Cooling capacity according to DIN EN 14240/heating capacity according to DIN EN 14037 : 2016
Higher capacities possible on a project-specific basis. Aar = Active area ratio.

Subject to technical changes.



A dependable partner

Decades of experience

Barcol-Air is your professional partner. We have gained decades of experience in the construction and installation of radiant ceiling systems in many countries around the world.

Expertise

Our employees have in-depth expertise in the field of radiant ceiling systems.

We strive to maintain our lead in the industry and consider the training and further development of our employees to be essential in ensuring they remain at the cutting edge of technology.

That is why we always have the resources and expertise required to install and maintain reliable systems for you.

Help and support

We support our customers in all phases of their projects – from the initial idea right through to commissioning the ceiling.

Reference projects



Beyond Gravity Circle, Zurich Airport



Mercato, Duisburg



Porsche Museum, Stuttgart



SXB Südkreuz, Berlin



Vector Informatik, Stuttgart



Mekkah Clock Tower, Mecca

Visit our website: barcolair.com

Feel good **inside**

