

**KNOW
HOW
CREATES**

smart
savings in
VAV zone
control

HVAC
CONTROLS & POWER

FLOOR HEATING
ELECTRIC

FLOOR HEATING
HYDRONIC

OJ GreenZone™
ZONE CONTROL FOR VAV SYSTEMS

OJ ELECTRONICS

**KNOW
HOW
CREATES**

system thinking
at its best

OJ GreenZone™ Master

The Master can be accessed and operated via the built-in web server, by connecting it to a Building Management System (BMS), or via a smartphone/tablet/laptop. Up to five Masters can be connected to a single AHU, each controlling up to 25 modules.



For four decades OJ Electronics has been in the business of making HVAC systems more efficient and easier to install and operate. The OJ GreenZone™ is a perfect example of the OJ Electronics approach to system thinking: we offer a combination of master controls, modules and room panels that gives you complete control of each individual room or zone in your building's VAV system – whether that system is based on air handling

units fitted with controls from OJ Electronics or from another manufacturer.

The result? Full individual control of up to 125 individual rooms or zones for each AHU. Air quality and temperatures are automatically regulated to match your comfort requirements. And major energy savings – up to 65% – translate directly into money in the bank for building owners.

TAKING VAV SYSTEMS TO NEW LEVELS

The OJ GreenZone™ system has seen OJ Electronics venture into new territory: individual VAV zone control. HVAC solutions have been a core aspect of OJ Electronics for decades, and with the OJ GreenZone™ system we have combined our decades of application experience with the most recent research on how to make VAV systems as energy-efficient as possible. Creative touches include a unique beeper function that makes it easy for service staff to locate modules hidden behind ceiling tiles – and of course you can use your latest device to control your OJ GreenZone™ system.

OJ GreenZone™ modules

Available in three different versions to suit your system needs, the modules adjust VAV damper operation to bring you dual benefits: greater comfort and greater savings.

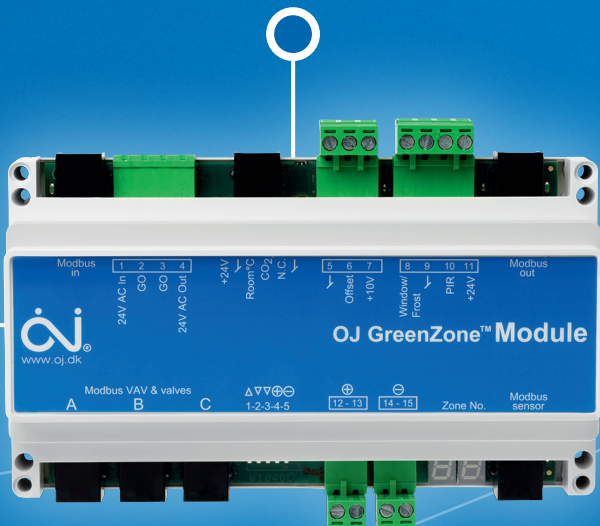

ZONE CONTROL MADE SIMPLE

The OJ approach to zone control centres involves three components: master units, zone modules and room panels. Zone modules and room panels can be used together as stand-alone solutions, while the use of one or more masters ensures maximum energy efficiency in large buildings.

OJ RPT-20T Room Panel

The all-new Room Panel allows users to adjust fan speed and temperature within parameters set by you.



PLUG & PLAY

The OJ GreenZone™ is quite literally a plug & play solution: the QuickPlug™ Modbus connection eliminates the risk of installation errors commonly seen in less sophisticated systems, and the entire system configures itself. For example, the Master automatically assigns addresses to each module.



ENERGY EFFICIENCY

Energy efficiency is about more than money – it is about supporting sustainable development. And sustainability is also about feasibility. The OJ GreenZone™ system reflects this: it can reduce ventilation-related energy consumption in buildings by up to 65%, making a very real contribution to energy conservation while also saving money.



RELIABLE SOLUTION

The OJ GreenZone™ is exactly the kind of solution you expect from OJ Electronics: designed and manufactured with great care. Handling it is so simple – and all components are so sturdy – that you will barely notice your OJ GreenZone™ system in day-to-day operation. Just the comfort and the savings it brings.

How OJ GreenZone™ fits *your* system

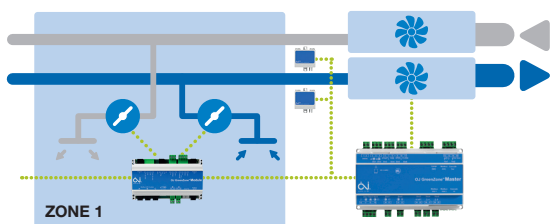

Use OJ Zone Module-A and PTH pressure transmitters to ensure constant duct pressure. The result: Lower air volumes, lower energy costs – and protection against excessive or insufficient pressure.

Constant pressure

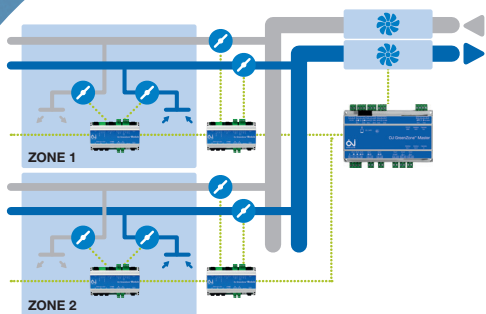

VAV dampers (Direct Modbus or MP-Bus) can be configured as branch dampers that optimise branch pressure, energy consumption and noise. Each Master can control up to 2 x 5 branch dampers.

Branch dampers

Room comfort



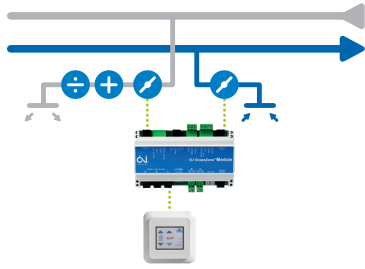

Use an optional room panel to adjust ventilation in a single room – based on sensor input.

Common extract

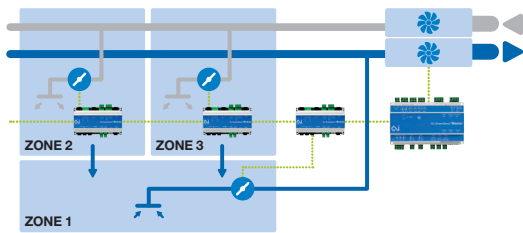

Connect zone modules to VAV dampers (Modbus or MP-Bus versions) and let the Master provide balanced ventilation at all times. Each Master can control up to five common extract ducts.

Damper position approach

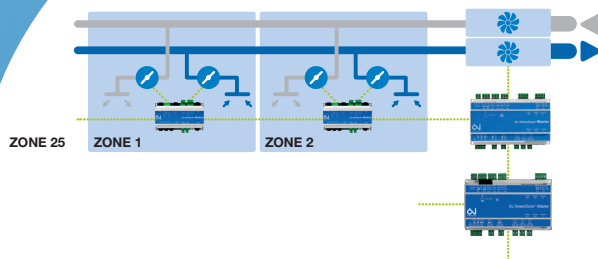

Connect zone modules to VAV dampers (Modbus or MP-Bus) – and let the Master regulate supply and return fan speeds for minimal pressure loss and maximum energy efficiency.

The choice is yours

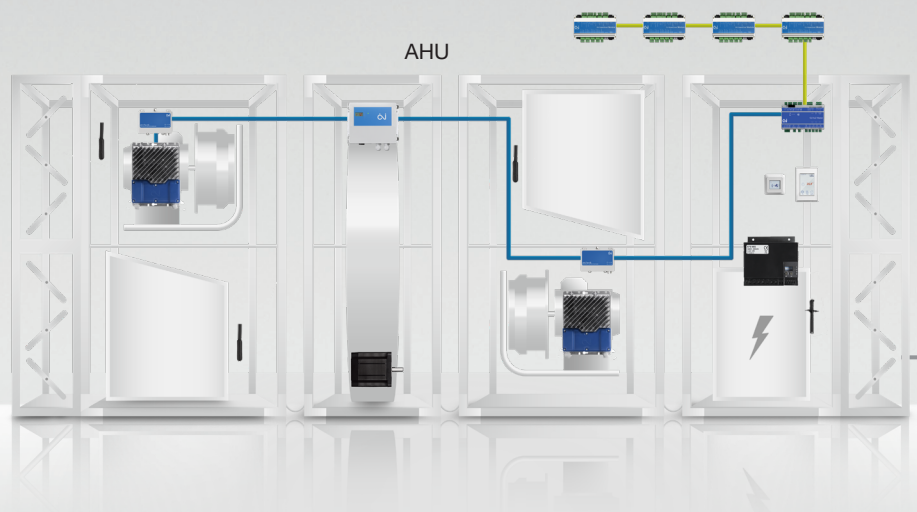

The OJ GreenZone™ system is compatible with a wide range of AHU controls – such as the OJ Air2.

THREE MODULE TYPES AVAILABLE

Your system can be based on three different zone modules, each with its own specific advantages. All modules adjust air flows based on sensor input: temperature, VOC, CO₂ and/or humidity. And they automatically detect all sensors attached.

Bus versions also monitor and adjust damper positions and air volume to optimise comfort and energy consumption.



Easy operation

CONTROL IN THE PALM OF YOUR HAND

Adjust, monitor and control wherever, whenever. Thanks to WiFi connectivity, all modules can be operated via your smartphone, tablet or laptop/PC.

PRE-INSTALLED SOFTWARE – AND EASY UPDATING

The software controlling the zone modules is stored in the Master unit. All modules in the network can be easily updated by replacing the SD memory card.

OJ Zone Master

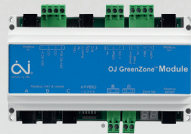
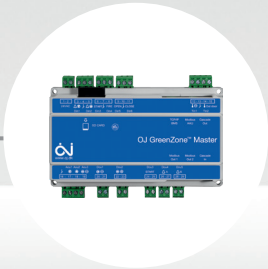

OJ Zone Module-M

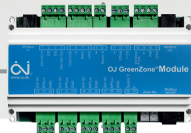

OJ Zone Module-MP

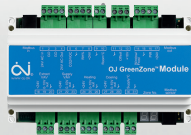

OJ Zone Module-A

OJ RPT-20T



OJ Zone Module-M

The OJ Zone Module-M is used in conjunction with Direct Modbus VAV dampers in each room – and the RJ12 plug eliminates the risk of wiring errors.

OJ Zone Module-MP

The OJ Zone Module-MP is used in conjunction with MP-Bus VAV dampers. The MP module brings you the best of both Buses, allowing you to benefit from standard MP-Bus VAV dampers, valves, and 6-way valves alike.

OJ Zone Module-A

The OJ Zone Module-A is used in conjunction with standard 0–10V VAV dampers for traditional solutions that maintain constant pressure in the supply ducts.



TOUCH SCREEN ROOM PANELS

The full-colour touch screen room panels let users control the fan speed and temperature in their room, allowing them to their personal comfort within the overall parameters of your OJ GreenZone™ system.

Fast installation

JUST PLUG & PLAY

Installation is a simple matter of plug & play: the combination of QuickPlug™ Modbus and built-in software ensures that OJ GreenZone™ saves valuable installation time.

SIMPLE CONFIGURATION

The OJ GreenZone™ configures itself automatically: the Master automatically assigns addresses to each zone module. This eliminates the need for complicated DIP switches – as well as the risk of blocking the network due to random address conflicts.

NO PROGRAMMING NECESSARY

Installers simply plug in the components and fine-tune the settings. Each room or zone can be configured to ensure ideal climate and operation – and a single OJ GreenZone™ solution can handle up to 125 individual zones.

QuickPlug™ Modbus

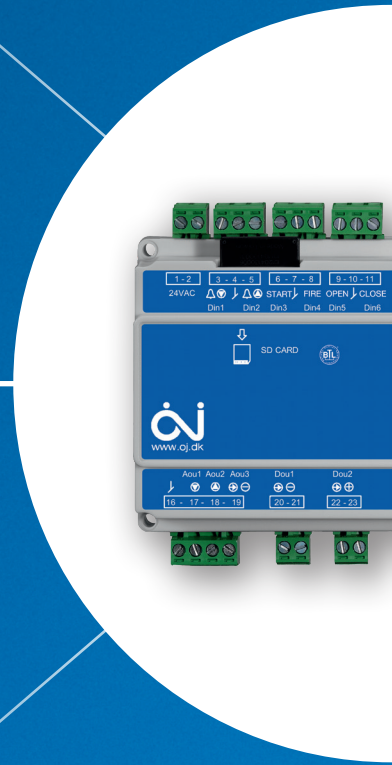

BMS Connectivity

OJ GreenZone™ is easily connected to your building management system.

- For small and medium-sized plants, the built-in web server will be enough to meet your needs
- For large plants, the built-in BACnet and Modbus features eliminate the need for extra gateways



Up to 65% energy savings

OPTIMISED FOR EFFICIENT PERFORMANCE

Enhanced AHU control and optimised temperature, air and water flow bring energy savings of up to 65%.

DEMAND-CONTROLLED FAN SPEED

In most systems, fans run at full speed or not at all. With OJ GreenZone™ control, the fan operation automatically reflects each room's change of use and needs, which greatly reduces energy use and costs.

SUMMER / WINTER COMPENSATION

With summer/winter compensation, OJ GreenZone™ adjusts temperature setpoints in accordance with the conditions outside. No programming is necessary: simply connect an outdoor temperature sensor to the Master unit.

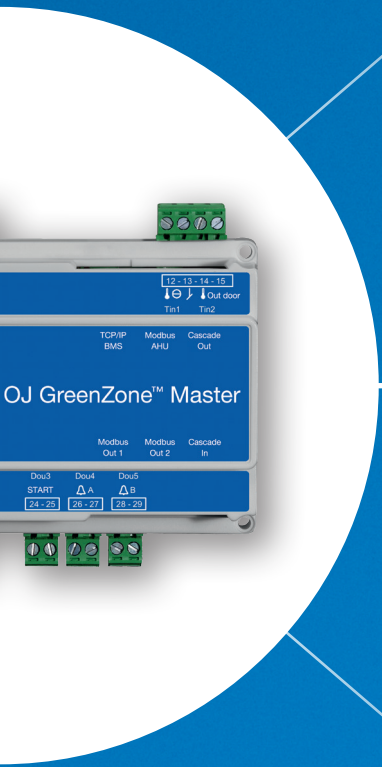

Recommended requirements for energy consumption and airflow rate

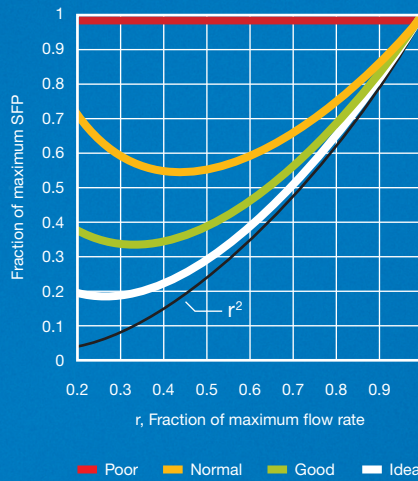

INDEPENDENT REPORT CONFIRMS OJ GreenZone™ SAVINGS

The efficiency of the OJ GreenZone™ approach is confirmed by independent research. A recent guidebook from Norwegian research institute Sintef explains the theory – and the OJ GreenZone™ system belongs firmly in the 'Good' category.

2.1.5 USE OF SPECIFIC FAN POWER (SFP)

It is important to clearly specify requirements in terms of SFP in order to get an energy efficient DCV system. DCV systems are not necessarily energy efficient.

The figure shows the variation of SFP according to the airflow rate for an ideal, good, normal and poor ventilation system, respectively (Schild and Mysen, 2009).

The differences lie in the fact that some systems regulate the airflow rate by using unnecessary throttling.*



*Mads Mysen, Peter Schild, Axel Cablé: Demand-controlled ventilation – requirements and commissioning, Sintef, 2014

Product overview

OJ ZONE MASTER

The OJ Zone Master uses sophisticated algorithms to maximise energy efficiency and comfort based on damper positions – and it can handle both branch dampers and common extract zones. Each Master controls up to 25 Modules, which are monitored and controlled by means of the Master's built-in web server and BMS interface.

- Energy-efficient VAV operation
- QuickPlug™ Modbus installation
- Automatic configuration
- Intuitive web server
- BMS interface



OJ ZONE MODULE-MP

The OJ Zone Module-MP is used in conjunction with MP-Bus VAV dampers, controlling damper positions and air volumes for energy-optimised operation.

- For MP-Bus VAV dampers
- Controls air quality and temperature
- QuickPlug™ Modbus installation
- Automatic configuration

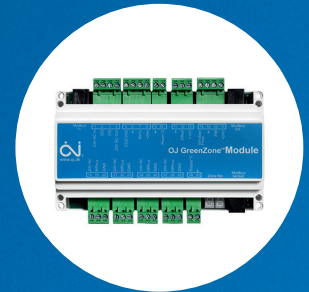

OJ ZONE MODULE-M

The OJ Zone Module-M is used in conjunction with Direct Modbus VAV dampers, controlling damper positions and air volumes for energy-optimised operation.

- For Direct Modbus VAV dampers
- Controls air quality and temperature
- QuickPlug™ Modbus installation
- Automatic configuration

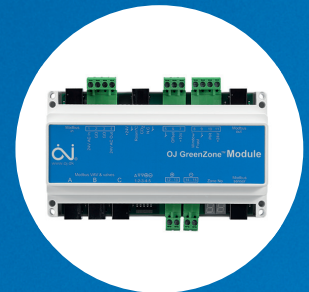

OJ ZONE MODULE-A

The OJ Zone Module-A is used in conjunction with standard 0–10V dampers, maintaining constant pressure in supply ducts.

- Standard 0–10V signals
- Controls air quality and temperature
- QuickPlug™ Modbus installation
- Automatic configuration

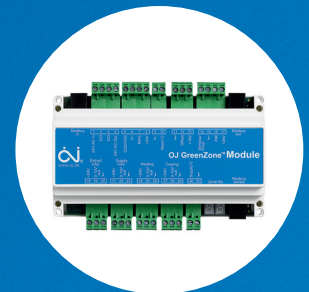

OJ RPT-20T • TOUCH SCREEN ROOM PANEL

The RPT panels allow users to adjust ventilation in a single room, ensuring optimum comfort while still conserving energy. Ideal for office settings, schools, shopping malls, airports, hotels, hospitals etc.

- User-friendly, intuitive operation
- 2" colour touch screen
- Built-in temperature sensor
- Programmable daily/weekly cycles



TTH-6040-W • ROOM TEMPERATURE TRANSMITTER

The TTH-6040-W is a stylish temperature transmitter that is designed to measure the temperature in a room. In larger rooms one or two work together with OJ-RPT-20T in order to measure the average temperature

- Room temperature
- Wall-mounting
- QuickPlug™ installation
- Modbus RTU



TTH-6202 • DUCT TEMPERATURE TRANSMITTER

The TTH-6202 is a temperature transmitter that is designed to measure the temperature in a ventilation duct. It is particularly flexible and developed for direct duct mounting in ventilation systems. The transmitter can be used in both large and small duct sizes.

- Duct temperature
- Telescopic mounting
- QuickPlug™ installation
- Modbus RTU



VTH-6202 • AIR QUALITY SENSOR

The VTH-6202 sensor measures air quality in ventilation ducts for demand-controlled air handling systems. Air quality is measured on the basis of its content of volatile organic compounds emitted by people, furnishings, cleaning agents, building materials, etc. The compact sensor has a QuickPlug™ Modbus connection for easy installation.

- Optimum measuring performance
- Easy installation with QuickPlug™ Modbus



HTH-6202 • HUMIDITY AND TEMPERATURE SENSOR

The HTH-6202 is a combined humidity and temperature sensor. Featuring Modbus communication, it is ideal for measuring relative air humidity and temperature in ventilation systems. Designed for installation directly in ventilation ducts, the sensor's adjustable length makes it equally suitable for large and small ducting systems.

- Measure and monitor air humidity and temperature with a single sensor
- Large measuring range from 0-100% RH
- All data is transferred to the controller via an RS485 RTU Modbus
- QuickPlug™ Modbus for easy installation
- Telescopic sensor from 50-250 mm



PTH-6202 • 0-2500 PA PRESSURE TRANSMITTER

PTH-6202 is a differential pressure transmitter with QuickPlug™ Modbus. Specially designed for air handling units, it very accurately measures and controls current duct pressure and/or pressure drops in filters and heat exchangers in Air Handling Units.

- Accurate measurement
- Cost-effective installation
- Specially developed for duct systems



OJ AIR2 EXT • I/O EXTENSION

The OJ Air2 EXT is specially designed for ventilation systems, it comes equipped with both digital and analogue inputs and outputs, allowing you to design more complex and energy-efficient ventilation systems. Particularly suitable for large and complex ventilation systems.

- Specifically designed for ventilation systems
- Both analogue and digital inputs and outputs
- QuickPlug™ Modbus
- Fully integrated in the Green Zone system
- Extend to suit your application



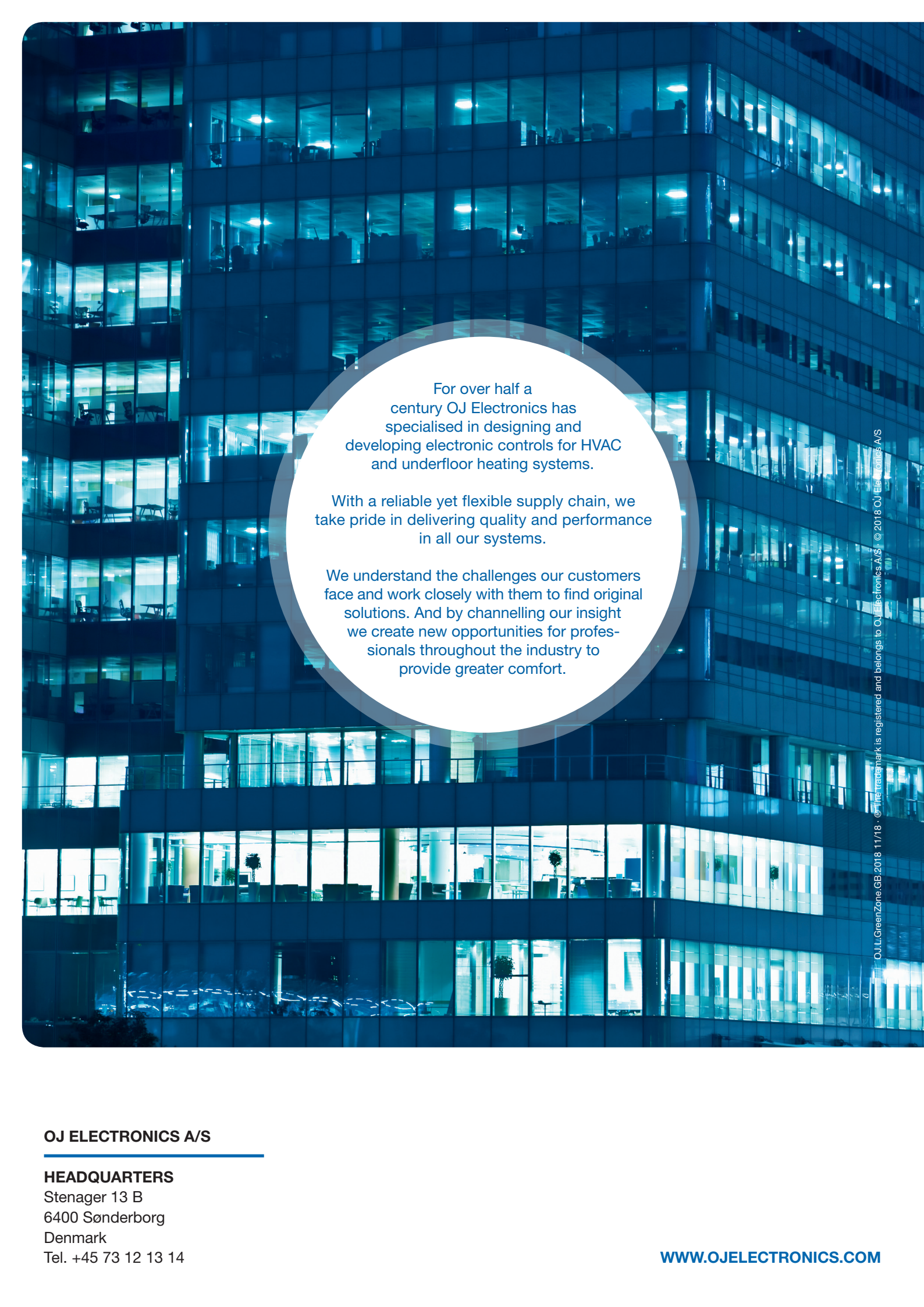

For over half a century OJ Electronics has specialised in designing and developing electronic controls for HVAC and underfloor heating systems.

With a reliable yet flexible supply chain, we take pride in delivering quality and performance in all our systems.

We understand the challenges our customers face and work closely with them to find original solutions. And by channelling our insight we create new opportunities for professionals throughout the industry to provide greater comfort.

OJ ELECTRONICS A/S

HEADQUARTERS

Stenager 13 B
6400 Sønderborg
Denmark
Tel. +45 73 12 13 14