

CADENZA

Sound attenuator with tapered acoustic baffles for rectangular ducts



QUICK FACTS

- Rectangular sound attenuator with connection to the outer casing, which also enables flange connection
- Excellent aerodynamic characteristics
- Low pressure drop via tapered acoustic baffle surfaces
- Type-approved, environmentally friendly, cleanable sound attenuating material, ISOVER Cleantec® PLUS
- Available with cleaning cover
- Available in an insulated version with 50 mm thick fire-resistant stone wool
- Connection sizes ranging from 400x300 to 2200x2200
- Included in the MagiCAD database
- Wet cleanable surface layer

Contents

Technical description	3
General.....	3
Function	3
Accessories	4
Cleaning covers T1 and T2	4
Flange connection T5	4
Fire-resistant insulation T3.....	4
Perforated sheet metal lining T4.....	4
Sizing	5
General.....	5
Dimensions	5
Dimension/Sound attenuation	8
Pressure drop.....	8
Inherent sound generation.....	9
System effect.....	10
Ordering key	11
Product.....	11
Accessories	11
Specification text.....	11

Technical description

General

The CADENZA has been developed to meet today's high requirements for sound attenuation and is especially well-suited for use out in duct systems.

Function

The CADENZA's low pressure drop has been achieved by designing the acoustic baffles according to the basic laws of aerodynamics through continuous tapered baffle surfaces.

The low pressure drop can e.g. be utilised for achieving the following:

- For reducing the space requirement in that a smaller sound attenuator can be selected.
- For reducing the pressure rise in the fan if the size is maintained.
- For reducing the inherent sound generation in the system thanks to lower velocity and lower pressure rise.
- For adapting the sound attenuator more easily to the connected duct system.

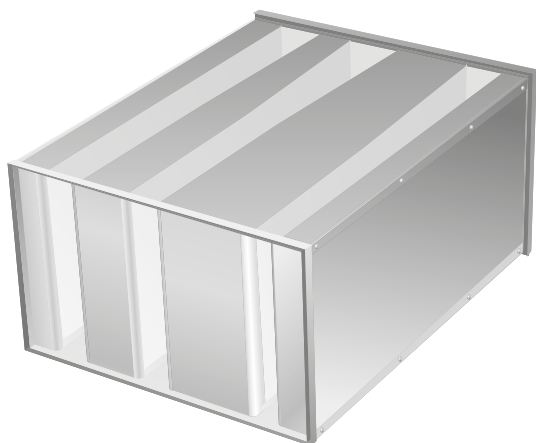

Figure 1. CADENZA's acoustic baffles are designed according to the basic laws of aerodynamics.

The CADENZA contains all the positive characteristics that previous Swegon sound attenuators have offered. By taking the properties of relevant materials into account and utilising the basic laws of aerodynamics, Swegon has optimized its sound attenuators with regard to the following factors:

- The acoustic properties of the sound attenuating materials.
- The thickness of the acoustic baffles.
- The width of the spaces between baffles.
- The length of the acoustic baffles.
- The surface covering.
- Cleanability

By combining these factors, Swegon can always offer the best sound attenuation with the lowest pressure drop to satisfy client requirements.

Design

- The CADENZA is made as standard of galvanized sheet steel to Corrosivity class C3 (VVS-AMA 2019 Standard).
- The ISOVER Cleantec® PLUS sound attenuating material has been granted type approval. (Type approval no. 2706/92 with regard to cleaning, cleanability, fibre entrainment, resistance to ageing emissions, etc.
- The standard CADENZA is supplied with slip clamp connections.

Maintenance

The CADENZA is under normal operating conditions a maintenance-free sound attenuator. If there are requirements for cleanability, the CADENZA can be ordered with factory-mounted cleaning cover. See Accessories. The cleaning cover then covers all the airflow passages to provide the best service accessibility. In many applications, it may however be appropriate to position the cleaning cover in the duct near the sound attenuator.

Environment

The declaration of construction materials is available for downloading from our website or can be ordered from one of our sales offices.

Installation

The slip-clamp connections on this product are intended for use as connection pieces for ducts only. The product should be suspended with a support beam under its entire width.

Loose acoustic baffles

The CADENZA can be supplied as loose acoustic baffles without clamp. For further information, contact Swegon.

Special version

In addition to the accessories and variants described in the catalogue there is scope for customised variants if required.

Swegon can also in consultation with the customer optimize the sound attenuator in relation to sound attenuation, size, air handling unit adaptation and choice of material (example: Stainless steel, aluminium zinc, etc). Please get in touch with Swegon for further information.

Accessories

Cleaning covers T1 and T2

For certain applications, a cleaning cover is required on or by the connection to the sound attenuator. For the CADENZA, this is available as CADENZA T1 accessory with cover which enables access to all the air passages between the baffles.

The Technical Data do not change if the CADENZA T1 accessory is used.



Figure 2. CADENZA with cleaning cover, CADENZA T1.

In applications in which the CADENZA must be equipped with a cleaning cover, this means that the cover will be located on the top/bottom of the sound attenuator (i.e. the B dimension is defined as width). Where, for example, due to restricted space the cleaning cover needs to be on the side, the B dimension should then be defined as the height (see figure above).

Sufficient open space must be provided so that the cover can be opened. The CADENZA T1 requires at least 300 mm open space in order to be able to remove the cover. CADENZA T2 requires fully open space a distance of approx. 700 mm.

Cleaning cover accessory

CADENZA T1: Uninsulated cleaning cover

CADENZA T2: Fire-resistant insulated cleaning cover

Flange connection T5

Available as an alternative to slip-clamp connection. Has robust flanges made of galvanized angle steel, with oval bolt holes designed to facilitate installation.

Flange connection accessories

CADENZA T5: Flange connection

Fire-resistant insulation T3

In many applications, sound attenuators are installed in fire-resistant insulated duct systems. In applications in which ventilation ducts are to be insulated with 50 mm thick fire-resistant stone wool, you can either install external insulation onto the sound attenuator directly at the building site or place an order for the factory-insulated variant. A factory-insulated variant is available as an accessory for the CADENZA.

You can choose to insulate the cleaning cover only (CADENZA T2) or insulate the whole sound attenuator (CADENZA T3)).

The technical data do not change if the CADENZA T2 accessory or the CADENZA T3 accessory is used.

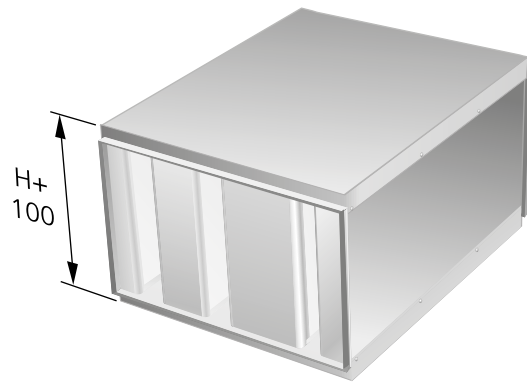

Figure 3. CADENZA in fire-resistant insulated version, CADENZA T3.

Fire-resistant insulation accessory

CADENZA T3: The sound attenuator is supplied insulated with 50 mm thick fire-resistant stone wool. N.B.! The sound attenuator's H dim. should then be increased by 100 mm.

Perforated sheet metal lining T4

If the air contains a high concentration of particles or if for some other reason a more robust design is required, the acoustic baffles can be covered with perforated sheet steel over the ISOVER Cleantec® PLUS insulation, CADENZA T4. The acoustic data and pressure drop are affected when the CADENZA T4 accessory is used.

Sheet metal lining accessory

CADENZA T4: Perforated sheet metal lining.

Sizing

General

All specified technical data apply to the CADENZA in the standard version. Dampers, duct bends and other equipment in the vicinity of the sound attenuator will increase its inherent sound generation and pressure drop. The specified data are based on a uniform air stream in and out of the sound attenuator.

See also the section on System effect and pressure drop.

If the inner acoustic baffle surfaces are lined with perforated sheet steel, this will increase the level of inherent sound generation. See the section on Inherent sound generation.

Dimensions

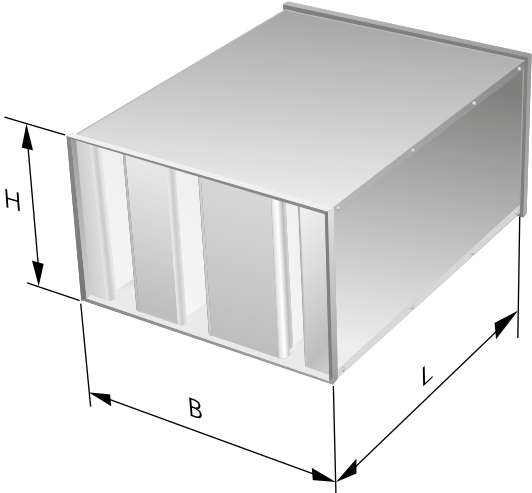

Figure 4. CADENZA, Dimension print

- B-dim.: 400, 500, **600, 700, 800**, 900, **1000**, 1100, **1200**, 1300, **1400**, 1500, **1600, 1800, 2000**, 2200
- H-dim.: **300, 400, 500, 600**, 700, **800**, 900, **1000**, 1100, **1200**, 1300, **1400**, 1500, **1600**, 1700, **1800**, 1900, **2000**, 2200.

The B and H dim. with grey marking and bold type are standard; products with other dimensions are available to special order.

L = see Technical Data Table

Weight = Contact your nearest Swegon Representative.

Technical Data

B dim. (mm)	Code	Length (mm)	Static integral attenuation, (dB) to ISO 7235								P-value
			63	125	250	500	1K	2K	4K	8K	
400	0418	650	4	8	12	18	22	20	11	8	2.7
	0428	1250	6	12	19	32	37	31	15	12	3.5
	0438	1850	8	16	26	45	47	38	19	16	5.5
500	0517	650	4	7	12	18	22	19	11	8	3.1
	0527	1250	6	12	19	31	36	30	15	12	3.5
	0537	1850	8	17	21	43	45	37	20	16	4.5
600	0616	650	4	8	13	21	28	26	17	13	4.7
	0626	1250	5	11	23	36	46	42	38	19	5.2
	0636	1850	6	13	31	50	50	48	34	23	9.1
700	0716	650	4	9	15	22	28	24	16	13	4.1
	0726	1250	5	12	23	36	41	36	23	18	4.5
	0736	1850	7	15	31	46	49	43	28	23	7.9
800	0816	650	4	10	15	23	27	27	15	10	3.7
	0826	1250	7	15	24	39	45	40	23	17	4.1
	0836	1850	8	19	32	48	50	45	30	22	7.2
	0817	650	4	8	12	18	22	20	11	8	2.7
	0827	1250	5	12	19	32	37	31	15	11	3.5
	0837	1850	7	15	26	44	48	38	19	16	5.5
900	0916	650	3	6	9	14	18	16	8	5	2.3
	0926	1250	4	10	16	28	33	27	9	6	2.7
	0936	1850	5	12	21	42	45	34	12	10	3.6
1000	1016	650	4	9	14	21	27	26	16	14	3.2
	1026	1250	6	13	23	35	45	40	24	18	3.8
	1036	1850	7	16	31	48	50	45	32	21	6.3
	1017	650	4	8	12	17	20	15	11	10	2.2
	1027	1250	5	11	18	28	32	22	13	12	2.5
	1037	1850	6	14	25	37	42	27	15	15	3.4
1100	1116	650	4	6	10	13	16	13	8	8	1.7
	1126	1250	5	9	17	22	27	19	12	11	1.9
	1136	1850	6	12	22	32	35	23	13	13	2.6
1200	1217	650	4	6	10	12	16	12	9	8	1.4
	1227	1250	5	9	16	20	24	17	12	11	1.5
	1237	1850	6	11	21	28	30	20	13	12	1.7
	1247	2540	7	14	26	36	37	23	15	13	1.9
	1218	650	5	8	13	19	23	20	12	9	2.2
	1228	1250	7	11	20	33	38	32	17	13	2.9
	1238	1850	8	15	26	44	48	39	21	18	4.8
	1248	2450	11	20	31	50	50	46	28	21	5.7
1300	1316	650	5	10	15	23	27	27	15	10	2.8
	1326	1250	6	15	24	39	45	40	23	17	3.2
	1336	1850	8	19	32	48	50	45	30	22	5.4
	1346	2450	10	24	38	50	50	50	40	26	6.5

Technical Data

B dim. (mm)	Code	Length (mm)	Static integral attenuation, (dB) to ISO 7235								P-value
			63	125	250	500	1K	2K	4K	8K	
1400	1416	650	4	7	10	14	17	13	8	8	1.6
	1426	1250	5	10	17	24	28	20	12	10	1.8
	1436	1850	6	11	22	33	38	25	14	11	2.4
	1446	2450	6	13	27	42	48	31	17	11	2.8
	1417	650	6	10	15	19	23	21	13	11	2.1
	1427	1250	8	14	24	33	40	35	20	15	2.7
	1437	1850	10	18	31	46	50	42	25	18	4.5
	1447	2450	13	23	34	50	50	49	30	21	5.4
1500	1526	1250	5	12	19	29	35	27	16	13	2.5
	1536	1850	6	16	26	40	44	34	18	16	3.5
	1546	2450	7	20	31	46	50	40	20	19	4.4
1600	1627	1250	5	11	18	27	32	22	13	12	2.0
	1637	1850	6	14	25	38	42	27	15	15	2.7
	1647	2450	8	17	29	49	50	33	18	17	3.3
	1628	1250	7	12	21	33	39	33	18	14	2.7
	1638	1850	8	15	28	44	48	40	23	18	4.6
	1648	2450	11	21	33	50	50	47	30	22	5.6
1800	1826	1250	7	15	24	39	45	40	23	17	2.7
	1836	1850	9	19	32	48	50	45	30	22	4.7
	1846	2450	11	24	38	50	50	50	40	26	5.6
	1827	1250	4	9	16	21	25	18	11	11	1.3
	1837	1850	5	11	21	30	33	21	13	13	1.9
	1847	2450	6	15	27	38	40	25	15	14	2.3
2000	2026	1250	6	13	20	31	37	31	16	14	2.2
	2036	1850	8	17	21	42	45	38	21	17	3.5
	2046	2450	10	21	33	47	50	46	25	20	4.1
	2027	1250	5	9	15	26	31	25	8	6	1.7
	2037	1850	6	11	20	40	44	33	10	9	2.2
	2047	2450	7	16	25	49	51	43	17	10	2.6
2200	2227	1250	5	11	18	27	32	22	13	12	1.8
	2237	1850	6	14	25	38	42	27	15	15	2.4
	2247	2450	8	17	28	50	50	33	18	17	2.9
	2228	1250	7	12	21	34	39	34	19	15	2.4
	2238	1850	8	16	28	45	48	40	24	19	4.1
	2248	2450	11	21	33	50	50	47	31	23	5

Dimension/Sound attenuation

- Calculate the required sound attenuation manually or use Swegon's ProSilencer acoustic calculation software (available at our home page).
- Select sound attenuators that manage the calculated need for sound attenuation in the low frequencies (mainly 125 Hz) under Technical data. Also check the sound attenuation in the higher frequencies.
- Check the H dimension of the sound attenuator to optimize the pressure drop; also observe the system effect.
- The p-value read in the table is used for determining the pressure drop of the sound attenuator. The higher the p value, the higher the pressure drop, see Nomogram 1.
- Check the sound attenuator's level of inherent sound generation.

Pressure drop

- Calculate the gross face area, B x H (m²).
- Find the contemplated airflow in Nomogram 1.
- Go vertically upward to the p-value obtained for the selected sound attenuator in the table.
- Read the pressure drop that refers to duct/duct installation.
- If you select an alternative other than duct/duct, correct the pressure drop using Diagram 1.

Multiply the pressure drop in Nomogram 1 by the value obtained from Diagram 1 depending on how the sound attenuator is to be installed.

Example:

A sound attenuator is positioned by a ventilation unit in a fan room. The airflow is 4 m³/s and the sound attenuator is mounted in a duct having a width of 1000 mm. Sound attenuator CADENZA 1016 with a p-value of 3.2 has been selected from Technical data. The sound attenuator is 1000 mm wide and 1100 mm high. The gross face area will be 1.1 m². Nomogram 1 gives a pressure drop of approx. 25 Pa. If the sound attenuator is instead installed in a duct/plenum, multiply the pressure drop by 2.3 according to Diagram 1. You will then obtain a pressure drop of approx. 58 Pa.

Nomogram 1. Determining the pressure drop

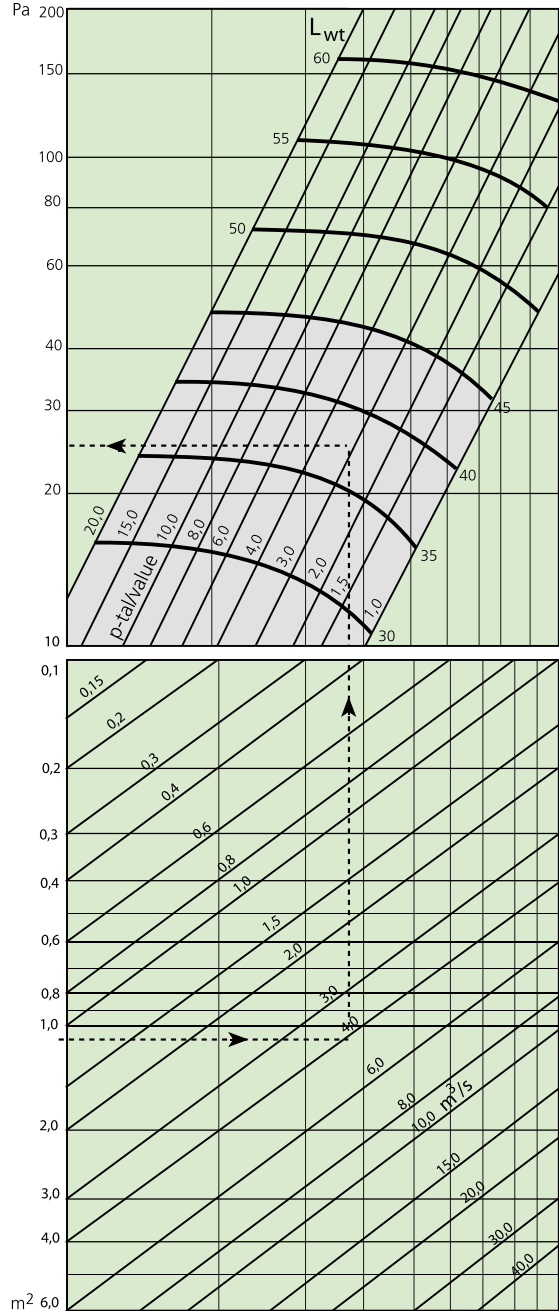
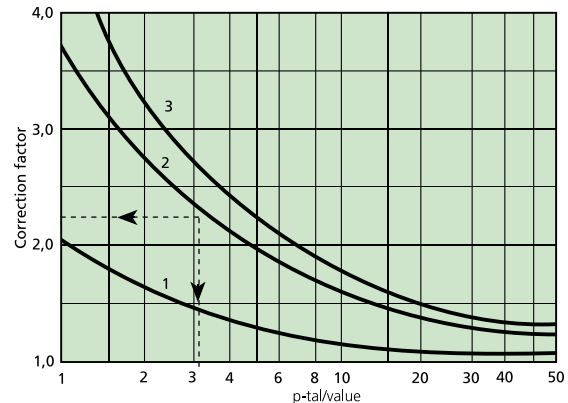

Diagram 1. Correction for different connection



Curve 1 Plenum/Duct; Curve 2: Duct/Plenum, Curve 3: Plenum/Plenum

Inherent sound generation

A sound attenuator not only attenuates sound, it also generates inherent sound when air passes through it at high velocity and if the pressure drop is substantial. Normally no problems will occur if you comply with the recommended operating range marked in Nomogram 1. Flow-generated sound curves have been plotted in Nomogram 1 as an aid for accurate calculations. You are welcome to use ProSilencer in which we not only specify inherent sound generation but also pressure drop. Specified L_{wt} -values are sound power level for CADENZA with reference value 10^{-12} W for an airflow of $1 \text{ m}^3/\text{s}$.

By correcting L_{wt} with K_1 for the CADENZA the sound power level in each octave band can be obtained. For the CADENZA with perforated sheet steel, first add 12 dB to specified L_{wt} and then correct it with K_2 .

Hz	63	125	250	500	1K	2K	4K	8K
K_1	-5	-5	-9	-11	-14	-17	-18	-20
K_2	-1	-2	-10	-17	-22	-24	-25	-20

Airflows other than $1 \text{ m}^3/\text{s}$ can be corrected using Diagram 2 below.

The generated inherent sound should be 8–10 dB lower in each octave band than the required sound power level downstream of the sound attenuator.

Diagram 2. Correction for other airflows

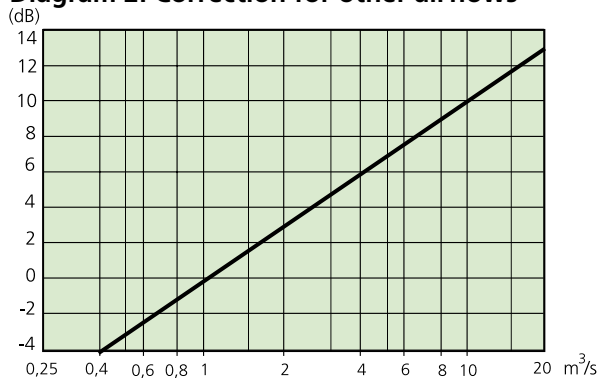

Example:

A sound attenuator is positioned by a ventilation unit in a fan room. The airflow is $4 \text{ m}^3/\text{s}$ and the sound attenuator is mounted in a duct having a width of 1000 mm. Sound attenuator CADENZA 1016 with a p-value of 3.2 has been selected from Technical Data. With a height of 1100 mm, the gross face area will be 1.1 m^2 . Nomogram 1 indicates $L_{wt}=38 \text{ dB}$. Correct with K_1 to break down the sound into octave bands and for $4 \text{ m}^3/\text{s}$ according to Diagram 2

Hz	63	125	250	500	1K	2K	4K	8K
L_{wt}	38	38	38	38	38	38	38	38
K_1	-5	-5	-9	-11	-14	-17	-18	-20
$4 \text{ m}^3/\text{s}$	6	6	6	6	6	6	6	6
L_w	39	39	35	33	30	27	26	24

System effect

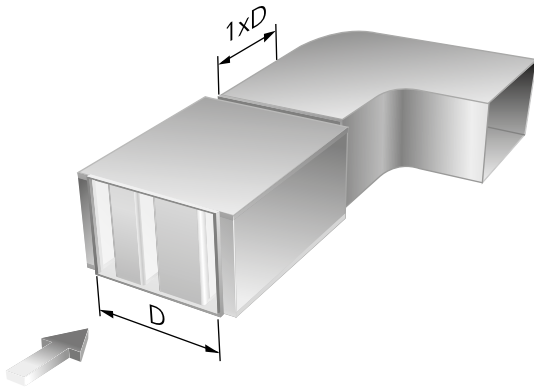

Figure 5. Sound attenuator upstream or downstream of a bend.

Sound attenuator installed upstream or downstream of a bend

The corrections below should be multiplied by the pressure drops specified in the diagram.

Sound attenuator upstream of a bend		Sound attenuator downstream of a bend	
Distance	Corr. factor	Distance	Corr. factor
3xD	1.1	1xD	1.2
2xD	1.2	0 (direct)	1.3
1xD	1.35		
0 (direct)	1.5		

Distance and D refer to the distance between the sound attenuator and bend or the biggest side of the sound attenuator.

Total pressure drop = Pressure drop of the sound attenuator according to Nomogram 1 x correction factor above.

Sound attenuator installed upstream or downstream of a plenum

The total pressure drop across the sound attenuator can be obtained by multiplying the correction factor according to Diagram 1 by the pressure drop according to Nomogram 1.

Sound attenuator installed upstream or downstream of a duct branch

A sound attenuator installed downstream of a duct branch can be compared to one installed downstream of a plenum. See Curve 1 in Diagram 1.

The total pressure drop across the sound attenuator can be obtained by multiplying the correction factor by the pressure drop according to Nomogram 1.

A sound attenuator installed upstream of a duct branch can correspondingly be compared to one installed upstream of a plenum. See Curve 2 in Diagram 1.

The total pressure drop across the sound attenuator can be obtained by multiplying the correction factor by the pressure drop according to Nomogram 1.

Sound attenuator installed by a ventilation unit

It is difficult to produce correct corrections for a sound attenuator installed by an air handling unit. This is mainly due to the fact that different air handling unit manufacturers have different solutions on the fan outlet. The most common solution is one where a relatively small fan outlet (produces high outlet velocity) is combined with a large duct connection (producing air velocities of approx. 4-6 m/s). Generally speaking, the angle of the transition between fan outlet and duct should not exceed 15 degrees. To ensure satisfactory distribution of the air stream, it is advantageous to utilise a diffuser.

Sound attenuator installed by a damper

Sound attenuators installed by dampers can cause substantial pressure drops. As the damper angle is increased, greater difference in velocity profile is generated. This increases the air velocity between the acoustic baffles of the sound attenuator and thus increases the pressure drop.

Sound attenuators connected in series

If the sound attenuators are connected in series, the basic rule should be to avoid a change in velocity profile between the dampers connected in series. If the length of straight ducting between the sound attenuators can be arranged to be sufficiently long (4 x D), you can at best calculate the stated pressure drop per individual sound attenuator. An important aspect is also to make sure that the acoustic baffles of one sound attenuator do not cover the spaces between the baffles of the next sound attenuator. For advice concerning series connection, contact Swegon.

Ordering key

Product

Rectangular sound attenuator

CADENZA a aaaa bbbb x cccc x dddd
 Version:
 Code
 According to Technical Data
 Dimensions:
 B x H x L

Accessories

- CADENZA T1 = Uninsulated cleaning cover
- CADENZA T2 = Fire-resistant insulated cleaning cover
- CADENZA T3 = Sound attenuator, insulated with 50 mm thick fire-resistant stone wool
- CADENZA T4 = Perforated sheet metal lining.
- CADENZA T5 = Flange connection

N.B.! If the sound attenuator is equipped with a cleaning cover, open space must be provided to enable the cover to be opened. CADENZA T1 requires approx. 300 mm open space. CADENZA T2 requires fully open space at a distance of 700 mm.

Specification text

Example of specification text to VVS AMA.

Swegon's type CADENZA rectangular sound attenuators, with the following attributes:

- Aerodynamically designed acoustic baffles for low pressure drop.
- Type-approved, insulation material, ISOVER Cleantec® PLUS.
- Sound attenuation in dB (to be specified in clear text for the various frequency bands).
- Pressure drop in Pa (to be specified in clear text).

Size	CADENZA a aaaa bbbb x cccc x dddd	xx items
	CADENZA T	xx items

Ordering example

Straight sound attenuator with code 0636 having a height of 600 mm conforming to the sound attenuating requirements that have been calculated. The sound attenuator shall be equipped with an uninsulated cleaning cover. The vertical open space available for installation is limited to max. 1300 mm which means that space is available for opening the cleaning cover (600+300 mm).

Ordering key:	CADENZA a 0636 600x600x1850
	CADENZA T1