





# WIRING DIAGRAM MURAL AIR HANDLING UNITS

 This wiring diagram is only an addition to our installation and operation manuals, available on our website for download.

 All internal components (fans, controls, sensors, actuators...) to the control board are pre-wired. The power supply must be connected to the safety isolating switch by a qualified electrician. Earthing is obligatory.

 All electrical connections must be made by a qualified electrician and in accordance with local rules and regulations.

 Residual current circuit breaker 300mA class B or B+

 Fuse protection (D-type, "slow")  
D – 10.000 A – AC3

Changes		Name	Date	Application:	Page
Name	Date	Draw.:	M.Sgreccia		General
		check.:	G.Beckers		
		Norm:		of	
Subject:	MURAL_Wiring TAC5 V2.spl7				19

**MURAL PX (TOP)**

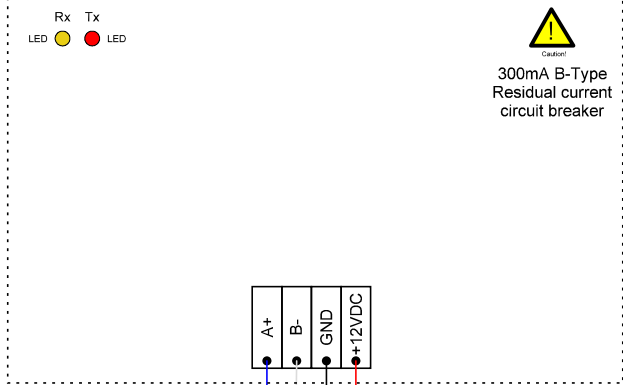

**MURAL P300/400T**

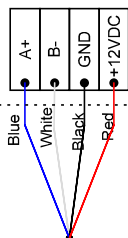
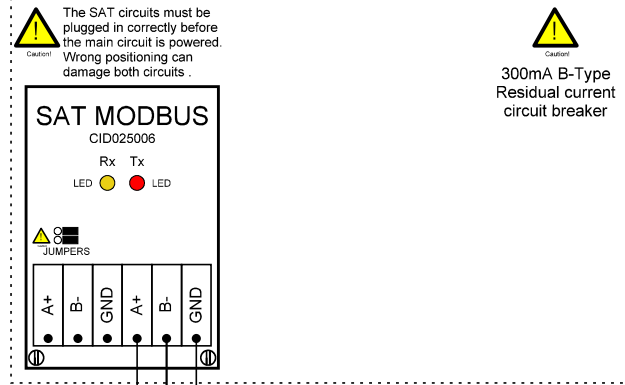

Modbus RTU RS485

**TACtouch**



The cables used in the network must comply to the RS-485 standard with twisted pair conductors. The cables must be shielded. Conductor Area >0.2 mm<sup>2</sup>. The total length must not exceed 100 meters.

**TACtouch**

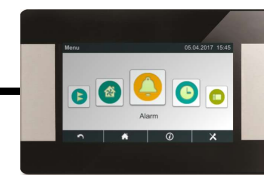

The cables used in the network must comply to the RS-485 standard with twisted pair conductors. The cables must be shielded. Conductor Area >0.2 mm<sup>2</sup>. The total length must not exceed 100 meters.

Changes			Name	Date	Application: <b>TACtouch</b>	Page
Name	Date	Draw.:	M.Sgreccia	11/06/2019		2
		check.:	G.Beckers			
		Norm:				of
Subject:	MURAL_Wiring TAC5 V2.spl7					19

TAC5 Controller

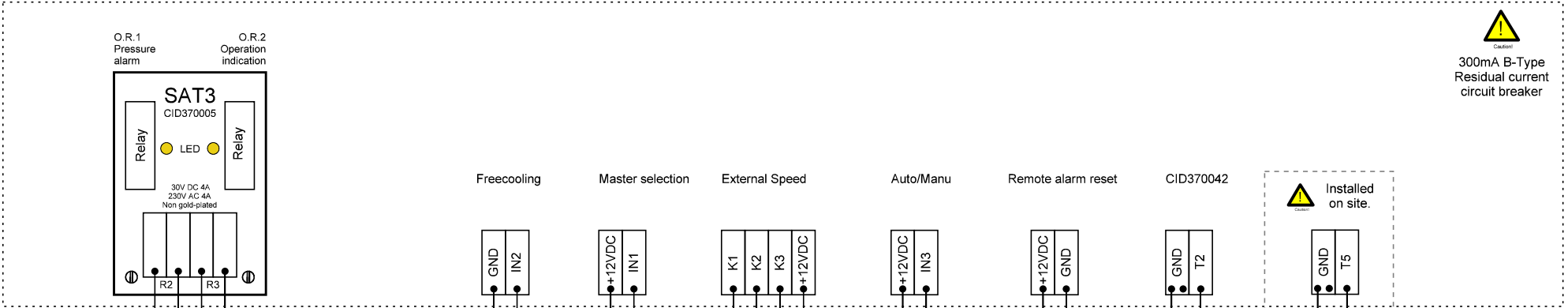

**Caution**  
300mA B-Type Residual current circuit breaker

**Default & Pressure alarm output**  
Closes when alarm (default or pressure)

**FAN ON / CT output**  
Closes when fans are running  
OR Closes to open dampers

**Freecooling input**  
Force bypass open (1) or Automatic (0)

**Master Selection**  
Input K1/K2/K3 (1) or HMI (0)

**External speed input**  
Low speed K1  
Medium speed K2  
High speed K3

**Auto/Manu input**  
Time schedule Manual = 0  
AUTO = 1

**Remote Alarm reset**  
1= Reset  
Push button N.O. Momentary Switch <1sec.

**Room temp. sensor**  
(Option) Replaces extract air temp. sensor

**Supply Air temp. sensor**  
ca. 1,5m after last coil

**Caution**  
Input IN2 must be assigned to BYPASS in advanced setup (assigned to FIRE ALARM by DEFAULT)

**Caution**  
Use gold-plated contacts only

Changes		Name	Date	Page
Name	Date	Draw.: M.Sgreccia	08/03/2019	3
		check.:		
		Norm:		
Subject:	MURAL_Wiring TAC5 V2.spl7			of 19
Application: Main Controller TAC5				

TAC5 Controller

 **300mA B-Type Residual current circuit breaker**

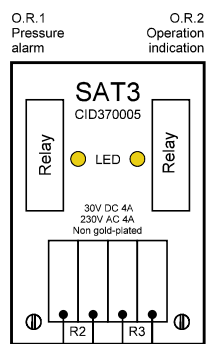

**Default & Pressure alarm output**  
Closes when alarm (default or pressure)

**FAN ON / CT output**  
Closes when fans are running  
OR Closes to open dampers

Master selection

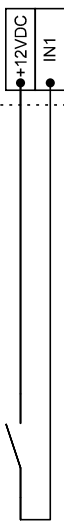

**Master Selection**  
Input K1/K2/K3 (1) or HMI (0)

 **prewired (1)**

External Speed

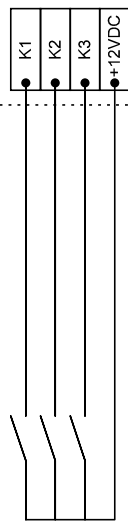

**External speed input**  
Low speed K1  
Medium speed K2  
High speed K3

Auto/Manu

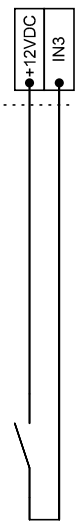

**Auto/Manu input**  
Time schedule  
Manual = 0  
AUTO = 1

Boost

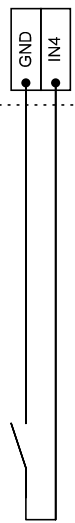

**Boost input**  
1= Forced boost

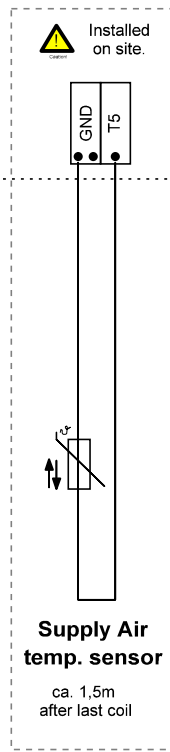

**Supply Air temp. sensor**  
ca. 1,5m after last coil

Changes		Name	Date	Configuration of function: <b>Basic setup / Air flow regulation / Constant pressure</b>	Page	
Name	Date	Draw.:	M.Sgreccia		08/03/2019	4
		check.:				
		Norm:		Application: <b>Constant airflow</b>	of 19	
Subject:	MURAL_Wiring TAC5 V2.spl7					

TAC5 Controller

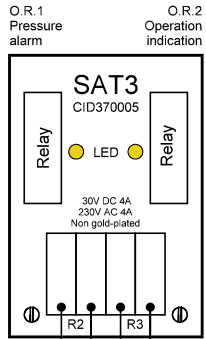
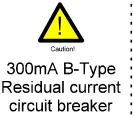

**Default & Pressure alarm output**

Closes when alarm (default or pressure)

**FAN ON / CT output**

Closes when fans are running OR Closes to open dampers

**Boost**

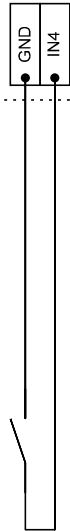

**Boost input**

1= Forced boost

**Master selection**

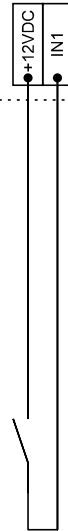

**Master Selection**

Input K1 (1) or HMI (0)



prewired (1)

**External Speed**

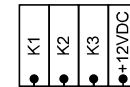

**Start / Stop input**

Active if IN1 = 1

**Demand control input 1**

CO2 wall sensor (CID370015)  
CO2 duct sensor (CID370016)  
RH sensor (CID370024)  
BMS output  
etc...  
Max. impedance: 1.500Ohm

**Demand control input 2**

CO2 wall sensor (CID370015)  
CO2 duct sensor (CID370016)  
RH sensor (CID370024)  
BMS output  
etc...  
Max. impedance: 1.500Ohm

Optional sensor in extract duct OR additional in supply duct (max of input 1&2)

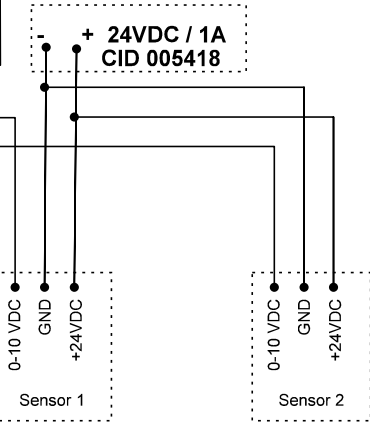

**Changes**

Name	Date	Draw.:	Name	Date
		M.Sgreccia		08/03/2019
		check.:		
		Norm.:		
Subject:	MURAL_Wiring TAC5 V2.spl7			

Configuration of function:

**Basic setup / Air flow regulation / Demand control**

Application:

**Demand control**

Page

5

of

19

TAC5 Controller



300mA B-Type Residual current circuit breaker

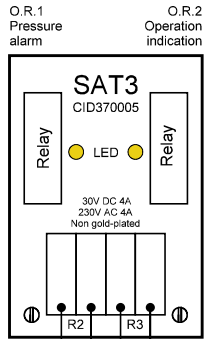

Pressostat input

Master selection

External Speed

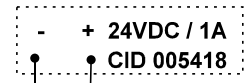
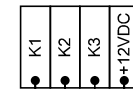

**Default & Pressure alarm output**

Closes when alarm (default or pressure)

**FAN ON / CT output**

Closes when fans are running OR Closes to open dampers

**Pressostat input**

External pressostat for filter clogging



**Master Selection**

Input K1 (1) or HMI (0)



prewired (1)

**Start / Stop input**

Active if IN1 = 1

**Supply air pressure sensor**

Analogue sensor 0-10VDC

Exhaust air pressure sensor when CP on Exhaust is configured



**Exhaust air pressure sensor**

Analogue sensor 0-10VDC

Only when CP on Supply+Exhaust is configured



GREEN LED ON: OK  
 GREEN LED Flashing: Pressure outside of set range  
 GREEN LED OFF: No power supply  
 YELLOW LED ON: >50Pa  
 YELLOW LED Flashing: Calibration  
 YELLOW LED OFF: <50PA

Position switch SW2:  
 0... +100Pa: 1  
 0... +150Pa: 2  
 0... +300Pa: 3  
 0... +500Pa: 4

Input IN2 must be assigned to Pa ALARM in advanced setup (assigned to FIRE ALARM by DEFAULT)

Changes

Name	Date	Draw.:	Name	Date
		M.Sgreccia		08/03/2019
		check.:		
		Norm:		
Subject:	MURAL_Wiring TAC5 V2.spl7			

Configuration of function:  
**Basic setup / Air flow regulation**

Application:  
**Constant pressure**

Page

6

of

19

TAC5 Controller

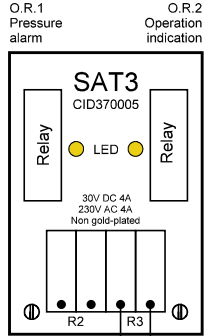
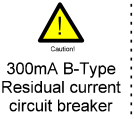

**CT OUTPUT**

When dampers are configured as present, this output is assigned to dampers opening/closing

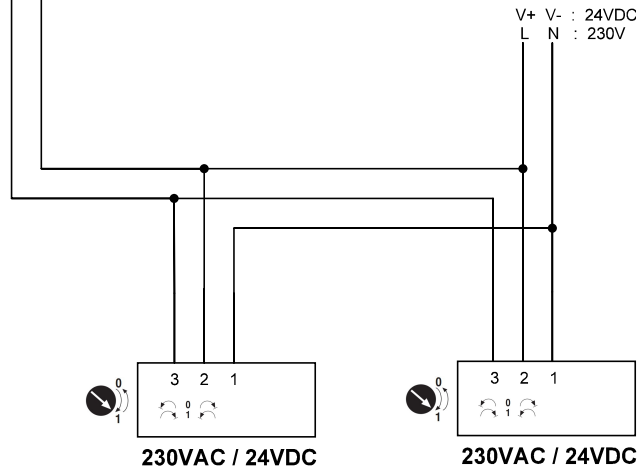

<b>Changes</b>			<b>Name</b>	<b>Date</b>	Configuration of function: <b>Basic setup</b>	<b>Page</b>
<b>Name</b>	<b>Date</b>	<b>Draw.:</b>	M.Sgreccia	11/06/2019		7
		<b>check.:</b>	G.Beckers		Application: <b>Motorised damper</b>	of
<b>Subject:</b>	MURAL_Wiring TAC5 V2.spl7					19

TAC5 Controller

  
300mA B-Type  
Residual current  
circuit breaker

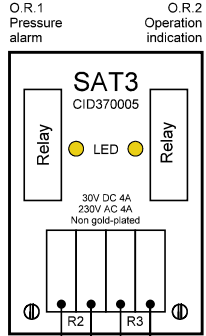

Remote alarm reset

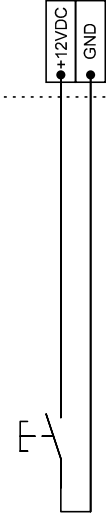
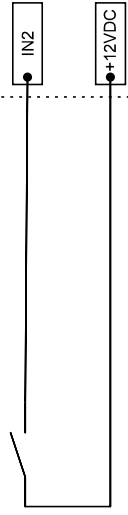

**Default  
& Pressure alarm  
output**

Closes when alarm  
(default or pressure)

**FAN ON  
/ CT  
output**

Closes when fans  
are running  
OR Closes to open dampers

**External fire  
alarm**

N.O.  
Configurable in  
advanced setup



Input IN2  
must NOT be assigned to Pa ALARM  
neither to BYPASS  
in advanced setup  
(assigned to FIRE ALARM by DEFAULT)

**Remote  
Alarm reset**

1= Reset

Push button N.O.  
Momentary Switch  
<1sec.



Use gold-plated  
contacts only

Changes

Name		Date		Configuration of function: <b>Basic setup/Fire alarm</b>	Page	
Date		Draw.:	M.Sgreccia		08/03/2019	8
		check.:				
Subject:		MURAL_Wiring TAC5 V2.spl7		Application: <b>Fire alarm</b>	of 19	



TAC5 Controller



  
300mA B-Type  
Residual current  
circuit breaker

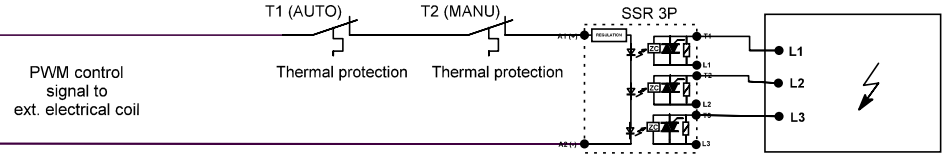

**KWin/KWout**  
(preheater/postheater)

  
SSR (solid state relay) and coil are  
2P monophasic for MURAL  
size under 1200

Changes		Name	Date	Configuration of function: <b>Advanced setup / Internal coils / Electric heater</b>	Page
Name	Date	Draw.: M.Sgreccia	08/03/2019		9
		check.:			
		Norm:		Application: <b>Electrical (pre/post) heater</b>	of 19
Subject:	MURAL_Wiring TAC5 V2.spl7				

### TAC5 Controller



The SAT circuits must be plugged in before the circuit is powered. The SAT must be plugged in correctly, wrong positioning can damage both circuits permanently.



300mA B-Type Residual current circuit breaker

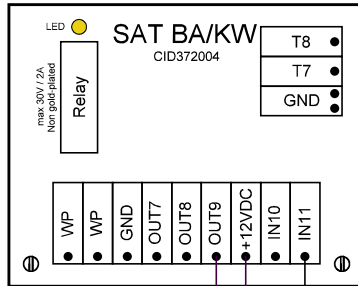

In case there is no preheater, follow diagram in sheet Elecrical (pre/post) heater

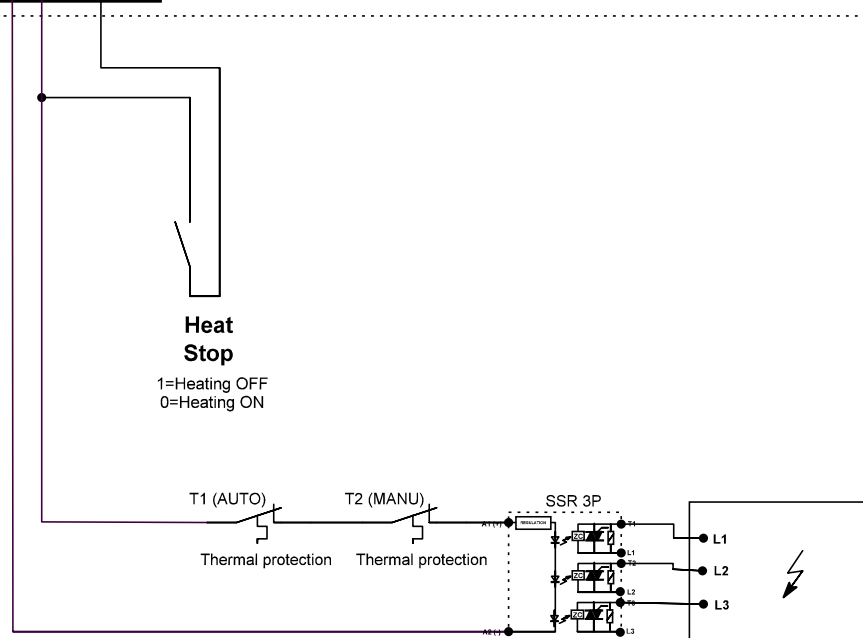

SSR (solid state relay) and coil are 2P monophas for MURAL size under 1200

Changes		Name	Date	Configuration of function: <b>Advanced setup / External coils / Electric (PWM)</b>	Page
Name	Date	Draw.: M.Sgreccia	08/03/2019		10
		check.:			
		Norm:		Application: <b>External elec. postheating</b>	of 19
Subject:	MURAL_Wiring TAC5 V2.spl7				

TAC5 Controller

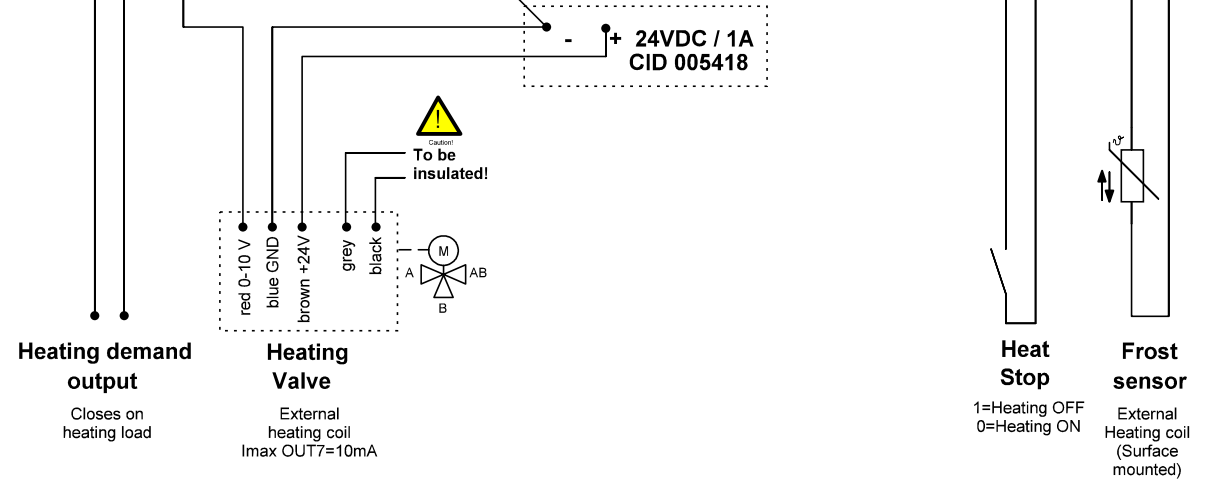
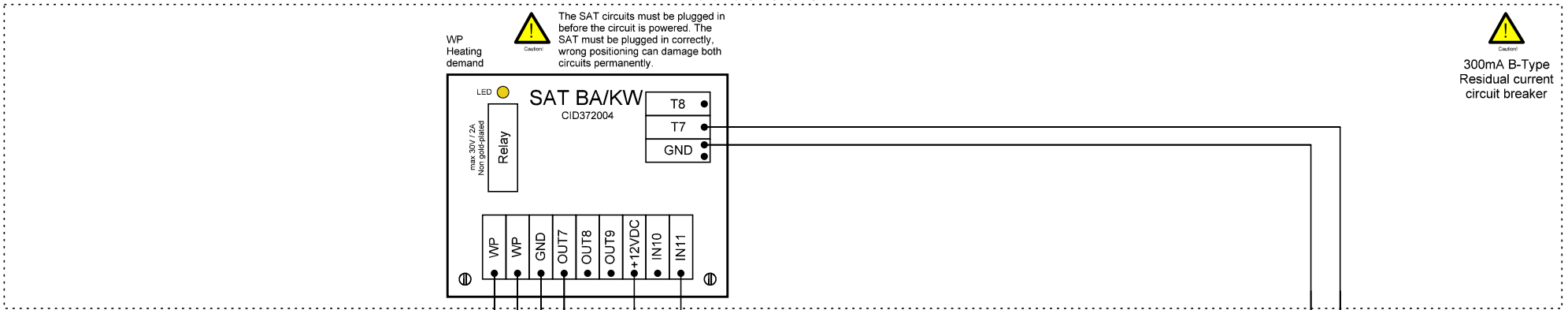

Changes		Name	Date	Configuration of function: Advanced setup / External coils / Hot water	Page
Name	Date	Draw.: M.Sgreccia	08/03/2019		11
		check.:			
		Norm:		Application: External hydr. heating coil	of 19
Subject:	MURAL_Wiring TAC5 V2.spl7				

### TAC5 Controller

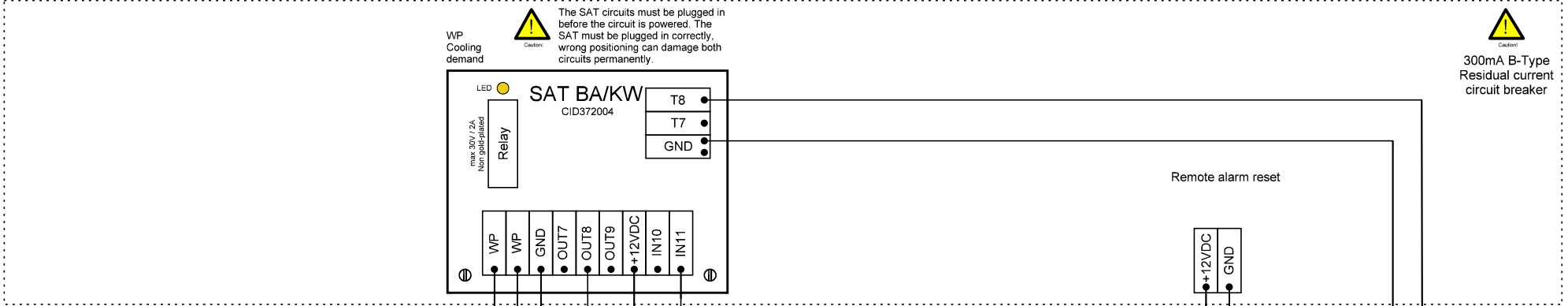

**Caution**  
The SAT circuits must be plugged in before the circuit is powered. The SAT must be plugged in correctly, wrong positioning can damage both circuits permanently.

**Caution**  
300mA B-Type Residual current circuit breaker

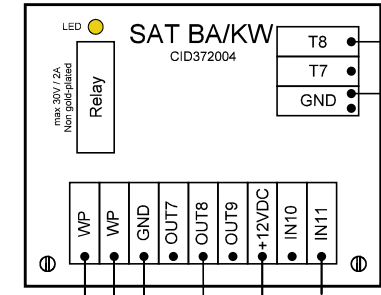

**Cooling demand output**  
Closes on cooling load

**Cool Stop**  
0=Cooling OFF  
1=Cooling ON

**Cooling Valve**  
External cooling coil  
Imax OUT8=10mA  
Imax OUT5=1A

**Remote Alarm reset**  
1= Reset  
Push button N.O. Momentary Switch <1sec.

**Frost sensor**  
External Cooling coil (Surface mounted)

**Caution**  
Use gold-plated contacts only

**Caution**  
+ 24VDC / 1A  
CID 005418

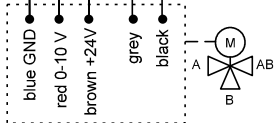

**Caution**  
To be insulated!

Changes		Name	Date	Configuration of function: <b>Advanced setup / External coils / Cooling</b>	Page	
Name	Date	Draw.:	M.Sgreccia		08/03/2019	12
		check.:				
		Norm:		Application: <b>External cooling coil</b>	of 19	
Subject:	MURAL_Wiring TAC5 V2.spl7					

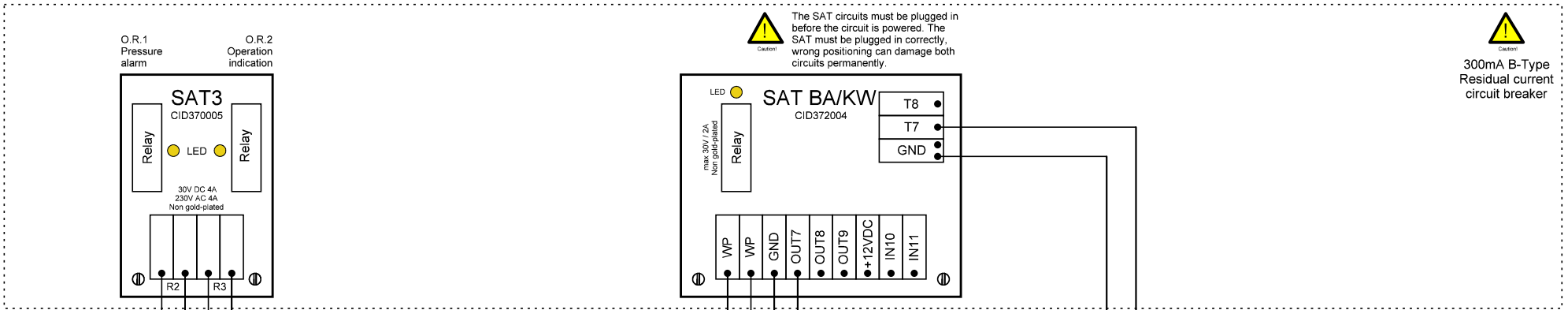

The SAT circuits must be plugged in before the circuit is powered. The SAT must be plugged in correctly, wrong positioning can damage both circuits permanently.



300mA B-Type Residual current circuit breaker

**Default & Pressure alarm / Heating demand output**  
**FAN ON / CT / Heating demand output**

Closes when alarm (default or pressure) OR Closes when in heating demand  
 Closes when fans are running OR Closes to open dampers OR Closes when in heating demand

**Cooling demand output**  
**Capacity output**

Closes on cooling load  
 0-10VDC output for capacity control  
 I<sub>max</sub> OJT7=10mA



WP contact can be used in alternative for heating indication (open) and cooling indication (closed) (this logic can be inverted in advanced setup)

**Frost sensor**

10k Ohm

Sensor to be replaced with 10kOhm resistance if frost protection is not needed

Changes		Name	Date	Configuration of function: <b>Advanced setup / External coils / Reversible</b>	Page
Name	Date	Draw.: M.Sgreccia	08/03/2019		13
		check.:			
Subject:	MURAL_Wiring TAC5 V2.spl7	Norm:		Application: <b>Change over / Master</b>	of 19



The SAT circuits must be plugged in before the circuit is powered. The SAT must be plugged in correctly, wrong positioning can damage both circuits permanently.



300mA B-Type Residual current circuit breaker

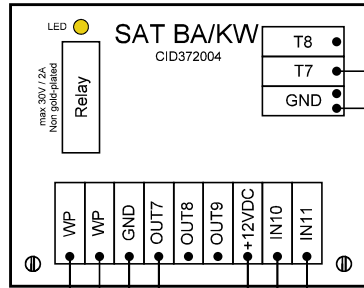

**Heating/Cooling demand output**

Closes on heating/cooling load

**Capacity output**

0-10VDC output for capacity control  
Imax OUT7=10mA

**Cooling input**

Close to deactivate cooling

**Heat/Cool input**

1=Cooling  
0=Heating

**Frost sensor**

Sensor to be replaced with 10kOhm resistance if frost protection is not needed

10k Ohm

Changes		Name	Date	Configuration of function: <b>Advanced setup / External coils / Reversible</b>	Page
Name	Date	Draw.: M.Sgreccia	08/03/2019		14
		check.:			
		Norm:		Application: <b>Change over / Slave</b>	of 19
Subject:	MURAL_Wiring TAC5 V2.spl7				

TAC5 Controller



The SAT circuits must be plugged in before the circuit is powered. The SAT must be plugged in correctly, wrong positioning can damage both circuits permanently.



300mA B-Type Residual current circuit breaker

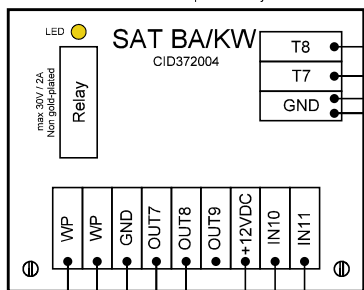

**Cooling demand output**

Closes on cooling load



in case of automatic changeover between heating and cooling, WP contact can be used in alternative to heating indication (open) and cooling indication (closed) (this logic can be inverted in advanced setup)

**Heating Valve**

External heating coil  
I<sub>max</sub> OUT7=10mA



To be insulated!

**Cooling Valve**

External cooling coil  
I<sub>max</sub> OUT8=10mA



To be insulated!

**Cooling input**

Close to deactivate cooling  
(Only if manual change over)

**Heat/Cool input**

1=Cooling  
0=Heating  
(Only if manual change over)

**Frost sensor**

External Heating coil  
(Surface mounted)

**Frost sensor**

External Cooling coil  
(Surface mounted)

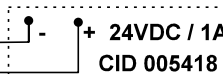

Changes		Name	Date	Configuration of function: <b>Advanced setup / External coils / Hot water + Cold water</b>	Page
Name	Date	Draw.: M.Sgreccia	08/03/2019		15
		check.:		Application: <b>Ext. heating &amp; Ext. Cooling</b>	of
Subject:	MURAL_Wiring TAC5 V2.spl7				19

AHU1

**Caution**  
 The SAT circuits must be plugged in correctly before the main circuit is powered. Wrong positioning can damage both circuits.

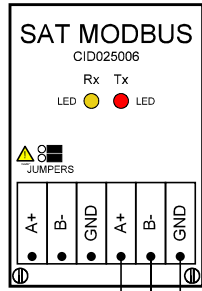

Modbus RTU RS485

AHU2

**Caution**  
 The SAT circuits must be plugged in correctly before the main circuit is powered. Wrong positioning can damage both circuits.

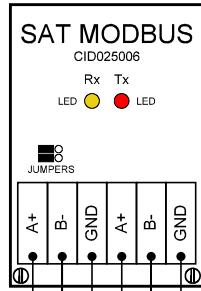

Modbus RTU RS485

Modbus RTU RS485

AHU3 ... AHU64

**Caution**  
 The SAT circuits must be plugged in correctly before the main circuit is powered. Wrong positioning can damage both circuits.

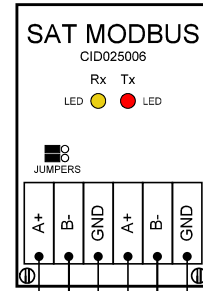

Modbus RTU RS485

Modbus RTU RS485

To BMS

The cables used in the network must conform to RS-485 Standard with twisted pair conductors. The cables must be shielded. Conductor Area 0.26 mm<sup>2</sup> to 0.50mm<sup>2</sup>. The total length must not exceed 1.000 meters.

Changes		Name	Date	Configuration of function: <b>Advanced setup</b>	Page	
Name	Date	Draw.:	M.Sgreccia		08/03/2019	16
		check.:				
		Norm:		Application: <b>Modbus RTU</b>	of 19	
Subject:	MURAL_Wiring TAC5 V2.spl7					



AHU1

**Caution!** The SAT circuits must be plugged in correctly before the main circuit is powered. Wrong positioning can damage both circuits.

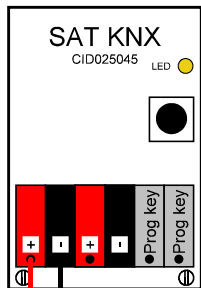

AHU2

**Caution!** The SAT circuits must be plugged in correctly before the main circuit is powered. Wrong positioning can damage both circuits.

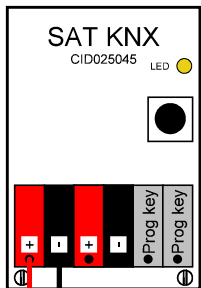

AHU3...AHU64

**Caution!** The SAT circuits must be plugged in correctly before the main circuit is powered. Wrong positioning can damage both circuits.

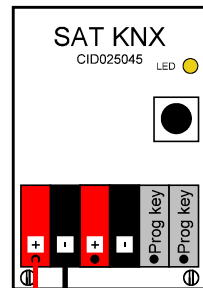

Changes		Name	Date	Configuration of function: <b>Advanced setup</b>	Page	
Name	Date	Draw.:	M.Sgreccia		08/03/2019	17
		check.:				
		Norm:		Application: <b>KNX</b>	of 19	
Subject:	MURAL_Wiring TAC5 V2.spl7					

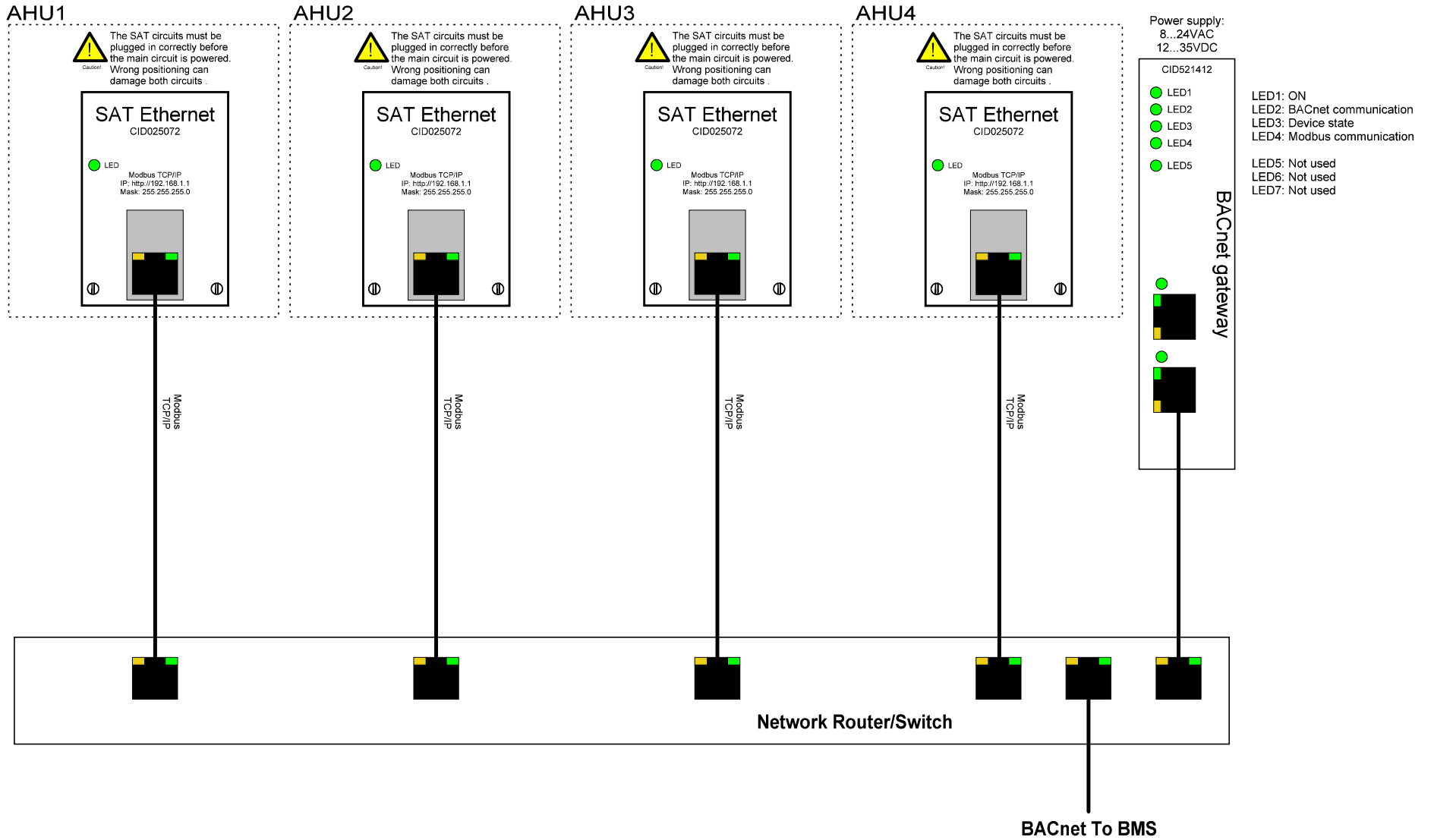

Changes		Name	Date	Configuration of function: <b>Advanced setup</b>	Page	
Name	Date	Draw.:	M.Sgreccia		08/03/2019	18
		check.:				
		Norm:		Application: <b>BACnet</b>	of 19	
Subject:	MURAL_Wiring TAC5 V2.spl7					

AHU1

AHU2

AHU3

AHU4

 The SAT circuits must be plugged in correctly before the main circuit is powered. Wrong positioning can damage both circuits.

 The SAT circuits must be plugged in correctly before the main circuit is powered. Wrong positioning can damage both circuits.

 The SAT circuits must be plugged in correctly before the main circuit is powered. Wrong positioning can damage both circuits.

 The SAT circuits must be plugged in correctly before the main circuit is powered. Wrong positioning can damage both circuits.

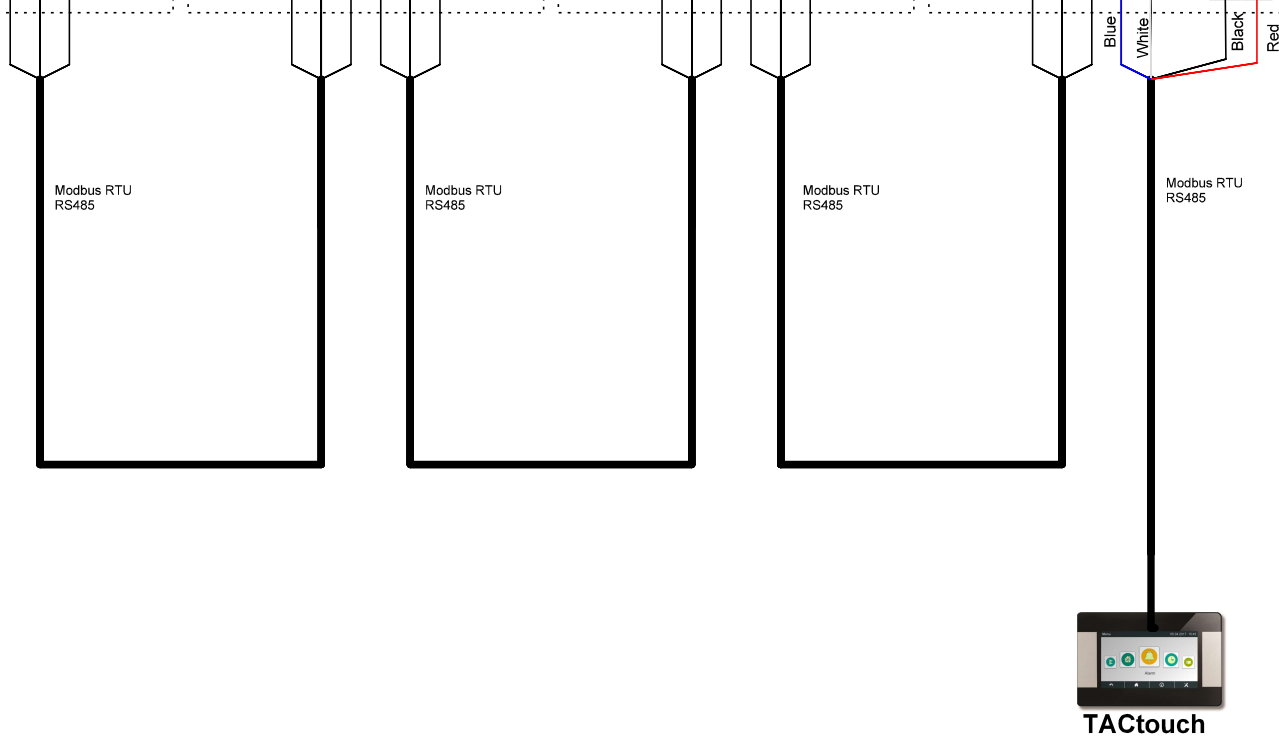
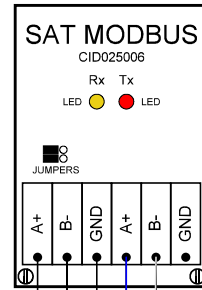
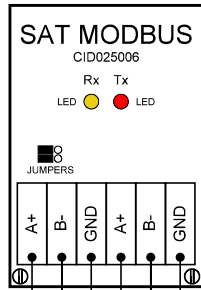
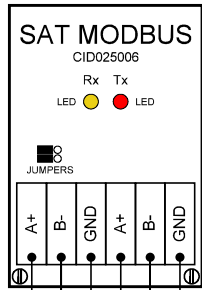
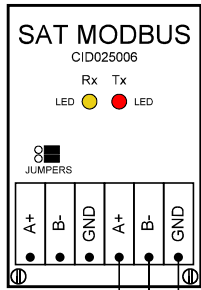

TACtouch

Changes		Name	Date	Configuration of function: <b>Settings Menu/ TACtouch setup/TACtouch master Network menu</b>	Page
Name	Date	Draw.: M.Sgreccia	08/03/2019		19
		check.:			
		Norm:		Application: <b>TACtouch centralised</b>	of 19
Subject:	MURAL_Wiring TAC5 V2.spl7				