

REACT V

Variable flow damper

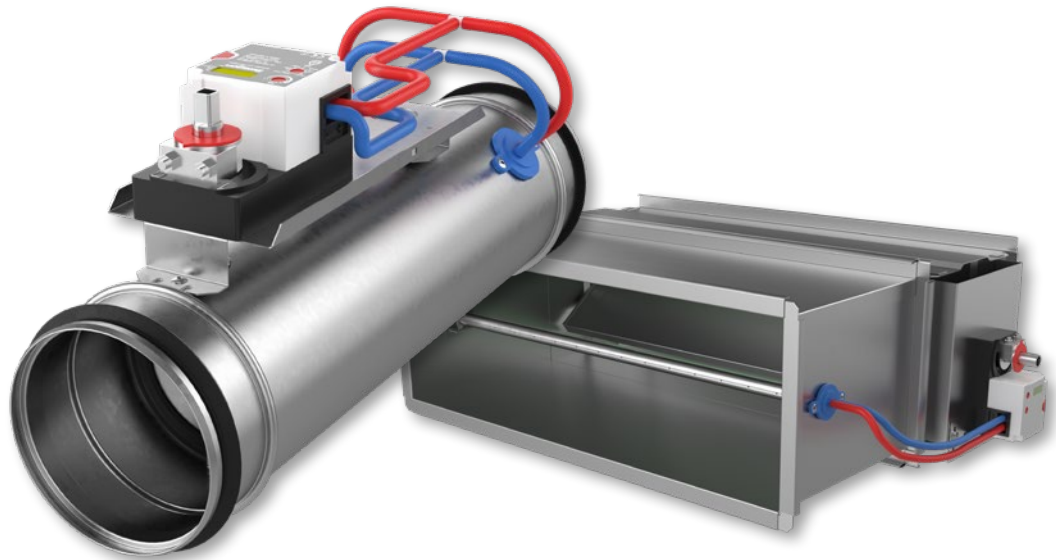

QUICK FACTS

- Variable or constant flow regulation
- Can be mounted directly at bends and duct transitions/reductions (circular)
- Rapid access to readings via the controller display
- Quick setting of parameters
- Analogue controls or Modbus control
- Can be easily anti-condensation insulated in the duct system
- Variants:
 - Circular connections: Ø100-630 mm
 - Rectangular connections: 200x200-1400x700 mm
 - Available with spring return actuator

REACT V Size	FLOWRANGE			
	Min.		Max.*	
	l/s	m ³ /h	l/s	m ³ /h
100	5	18	67	241
125	9	32	108	389
160	16	58	184	662
200	25	90	292	1051
250	40	144	470	1692
315	63	227	747	2689
400	102	367	1240	4464
500	164	590	1900	6840
630	300	1080	2950	10620

* Nominal flow (V_{nom}), based on 120 Pa in pressure reading.

Content

Technical description	3
General.....	3
Design	3
Functions.....	3
Materials and surface treatment.....	3
Project design / Typical room.....	3
Maintenance.....	3
Environment	3
Accessories	3
Technical data.....	4
Electrical data	4
Connections	4
Sizing	5
Air flows – all designs	5
Acoustic data – circular design	5
Sizing diagram – Circular, all designs	5
Acoustic data – rectangular design.....	7
Sound power in octave bands.....	7
Sizing diagram – rectangular design.....	7
Installation, torque, dimensions and weights.....	8
Circular design	8
Installation – all designs	8
Installation – circular version	8
Rectangular design	9
Installation – rectangular design.....	9
Specification.....	10
Specification text.....	11

Technical description

General

- Intended for flow regulation of comfort ventilation.
- Moist, cold and aggressive environments must be avoided.
- Can be installed in both supply and extract air systems.
- Pressure-independent, but does require a minimum pressure drop of 10 Pa across the damper.
- The minimum air flow must be considered during design.
- For good regulation, a minimum difference between V_{min} and V_{max} of 20% of the product's V_{nom} is recommended.

Design

- Motor: Normal or spring return.
- Options for selection of spring return (Order item):
 - Normally closed (NC).
 - Normally open (NO).
- Integrated air flow sensor.
- Analogue controls 0(2)-10 V or Modbus control.

Circular variant:

- Connection: Ø100-630 mm.
- Always supplied with dust protection.
- Motor shelf with 30 mm spacer to facilitate condensation insulation of the duct system.
- A factory-insulated model available on request.

Rectangular variant:

- Connection 200x200-1400x700 mm.
- Other sizes are also available on request.

Functions

- Variable or constant flow regulation.
- Measurement of air flow.
- Display for direct reading.
- Settings can be made directly on the controller with the help of a screwdriver.

Materials and surface treatment

- All sheet-metal parts are galvanized sheet steel (Z275).
- Measuring rods are aluminium.

Project design / Typical room

See separate documentation "REACT Description of functions & Wiring diagram", available for download via www.swegon.com.

Maintenance

The product does not require any maintenance/service, except for any cleaning when necessary. See the separate Instructions for Use, available on www.swegon.com.

Environment

The Building Materials Declaration is available from www.swegon.com.

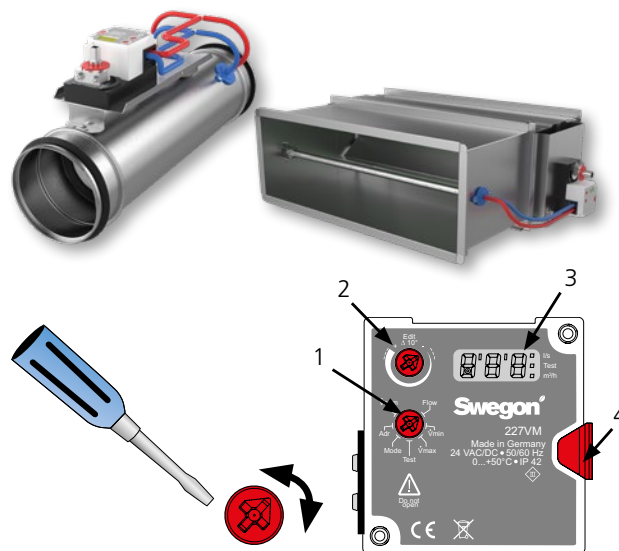

Figure 1. REACT V controller.

1. Function wheel
2. Edit wheel
3. Display
4. Release button (Not available on spring return)

Accessories

- REACT V COVER Ø – Cover panel for visible installation, circular design.
- FSR – Clamp/quick coupling for easy dismantling in a circular design for cleaning and inspection.
- DETECT Occupancy – Occupancy detector.
 - DETECT O V110 for wall and corner installation.
 - DETECT O T360 for ceiling installation.
- LUNA RC – Room controller for temperature regulation, with display.
- LUNA RE – Room controller for temperature regulation.
- DETECT IAQ – Carbon dioxide and temperature controller.
- DETECT IAQ OCS – Carbon dioxide and temperature controller, also detects occupancy.
- DETECT IAQ D – Carbon dioxide and temperature controller for duct installation.



Figure 2. Accessories.

1. REACT V COVER Ø
2. FSR
3. DETECT O V110
4. DETECT O T360
5. LUNA RC
6. LUNA RE
7. DETECT IAQ
8. DETECT IAQ OCS
9. DETECT IAQ D

Technical data

IP class:	IP42
Corrosivity class:	C3
Pressure class:	A
Leakage classes according to SS-EN 1751	
- Leakage class, casing:	C
- Leakage class circular damper, closed:	4
- Leakage class rectangular damper, closed:	3
Running times open/close (90°):	
5 Nm:	100 s
10 / 15 Nm:	150 s
Spring return actuator, running time electricity (90°):	
5 Nm:	100 s
10 / 20 Nm:	150 s
Return time spring:	max. 20 s (90°)
Ambient temperature	
Operation:	0 – +50 °C
Storage:	-20 – +50°C
RH:	10 - 95% (non-condensing)
CE marking:	2006/42/EC (MD) 2014/30/EU (EMC) 2011/65/EU (RoHS2)

Electrical data

Normal

Power supply:	24 V AC/DC ±15% 50 - 60 Hz	
Fixed connection cable, 1000 mm with cable size.	4 x 0.75 mm ² 2 x 0.38 mm ² <i>See figure 3 below.</i>	
Power consumption, for transformer rating:		
REACT V 5 Nm	2.5 W	4.0 VA
REACT V 10 Nm	2.5 W	5.5 VA
REACT V 15 Nm	3.0 W	5.5 VA
<i>See torque in table pages 8-9.</i>		

Spring return

Power supply:	24 V AC/DC ±15% 50 - 60 Hz	
Connection to screw terminals, cable size.	6 x 0.5-2.5 mm ² <i>See figure 4 below.</i>	
Power consumption, for transformer rating:		
REACT V-SR 5 Nm	5.6 W	7.8 VA
REACT V-SR 10 Nm	5.6 W	9.3 VA
REACT V-SR 20 Nm	8.6 W	9.3 VA
<i>See torque in table pages 8-9.</i>		

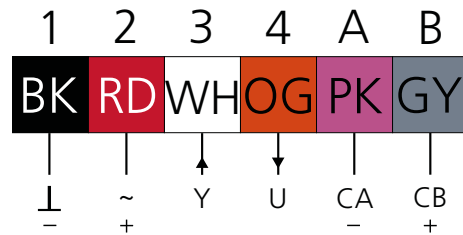

Figure 3. Connection, normal.

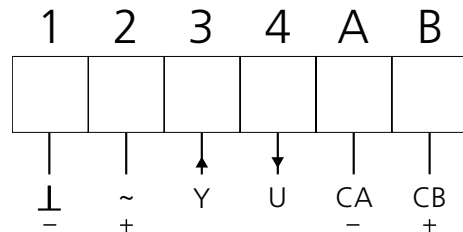

Figure 4. Connection, spring return.

Connections

1-2 – Supply voltage	24 V AC/DC
3 – Control signal (Y)	0..10/(2..10) V
4 – Actual value signal (U)	0..10/(2..10) V
A-B – Modbus	

Sizing

Air flows – all designs

- Important! Increased air flow gives increased duct velocity and increased sound level.

Acoustic data – circular design

Sound power level

- The diagrams show the A-weighted sound power (L_{WA} -dB), as a function of the air flow and pressure drop across the damper.
- Correct L_{WA} with correction factor K_{ok} from the tables below to obtain the sound power levels for each octave band ($L_W = L_{WA} + K_{ok}$).

Correction factors for conversion to sound power in octave bands:

L_{WA} = Sound level with A-filter but without room attenuation in the sizing diagram for duct products.

K_{ok} = Correction factor in octave bands.

K_{trans} = Correction factor in octave bands for transmitted sound.

Sound power in octave bands

$$L_W = L_{WA} + K_{ok} \text{ [dB]}$$

Correction factor, K_{ok}

Size	Mid-frequency (octave band) Hz							
	63	125	250	500	1000	2000	4000	8000
100	7	7	5	-1	-5	-10	-17	-22
125	7	9	6	-2	-4	-10	-19	-25
160	5	10	6	-3	-5	-11	-18	-24
200	5	10	5	-2	-5	-11	-19	-27
250	8	5	2	-3	-6	-10	-18	-24
315	4	6	3	-3	-6	-10	-18	-25
400	6	3	1	-3	-5	-10	-17	-26
500	3	0	-1	-3	-5	-10	-17	-28
630	3	-1	-2	-3	-5	-9	-17	-27
Tol. ±	6	3	2	2	2	2	2	2

Transmitted sound through uninsulated casing

$$L_W = L_{WA} + K_{trans} \text{ [dB]}$$

Correction factor K_{trans}

Size	Mid-frequency (octave band) Hz							
	63	125	250	500	1000	2000	4000	8000
100	-2	-9	-7	-10	-9	-10	-15	-22
125	-4	-9	-8	-13	-9	-12	-19	-27
160	-7	-9	-10	-15	-12	-15	-20	-28
200	-9	-11	-13	-16	-14	-16	-23	-32
250	-8	-18	-17	-19	-17	-17	-23	-31
315	-14	-19	-18	-21	-18	-19	-25	-34
400	-13	-23	-22	-22	-19	-21	-26	-37
500	-18	-28	-27	-24	-21	-22	-28	-40
630	-18	-27	-27	-24	-21	-21	-29	-38
Tol±	6	3	2	2	2	2	2	2

Sizing diagram – Circular, all designs

Air flow – Pressure drop – Sound level

- Specified sound levels, L_{WA} : 30, 35, 40, 45 and 50 dB(A).
- The data is for the sound created in ducts.
- 100% corresponds to the damper being fully open.
- ∇ = Min. flow, minimum flow for controllability
- Dashed lines 1 m/s to 8 m/s in duct velocity normally define the working range that REACT should be selected for

REACT V 100

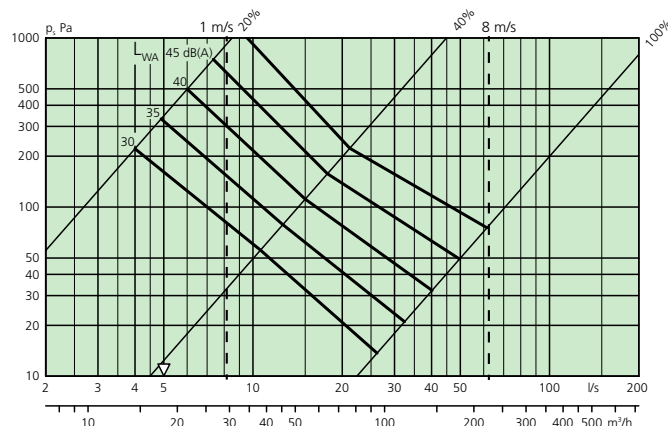

REACT V 125

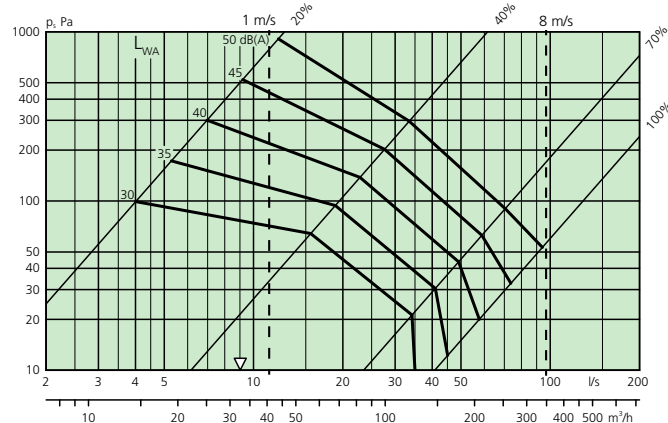

REACT V 160

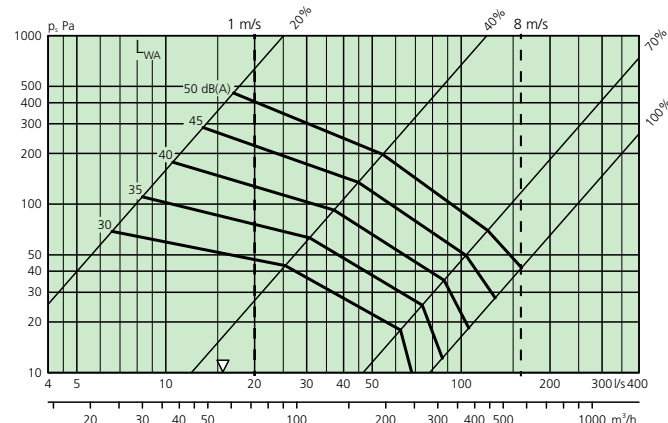

REACT V 200

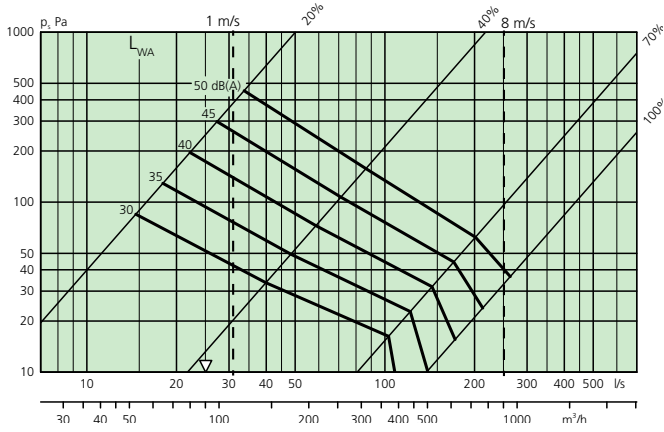

REACT V 400

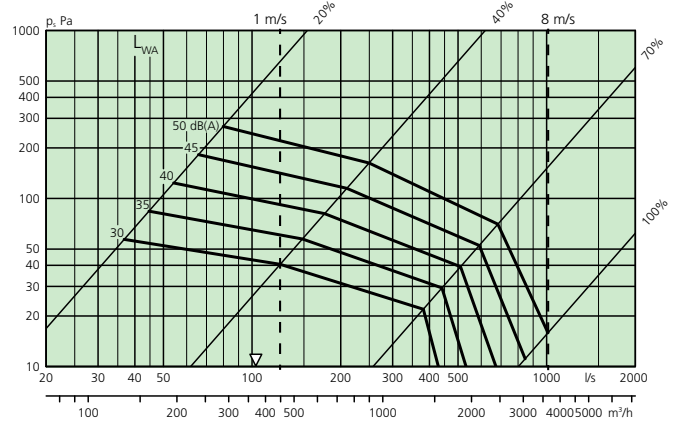

REACT V 250

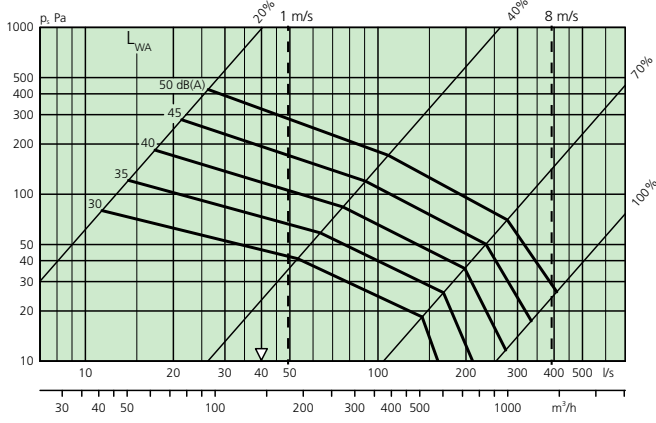

REACT V 500

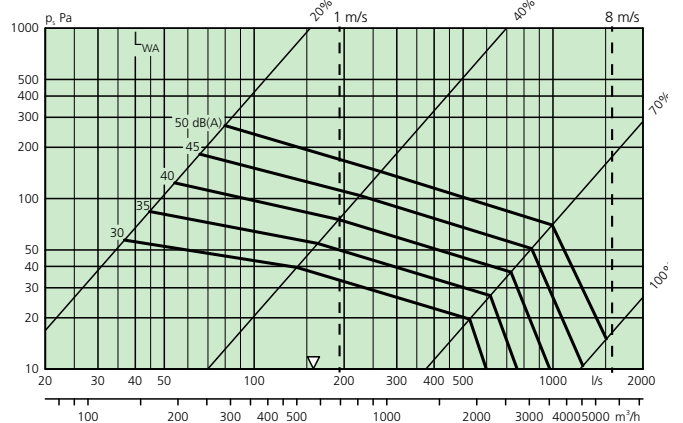

REACT V 315

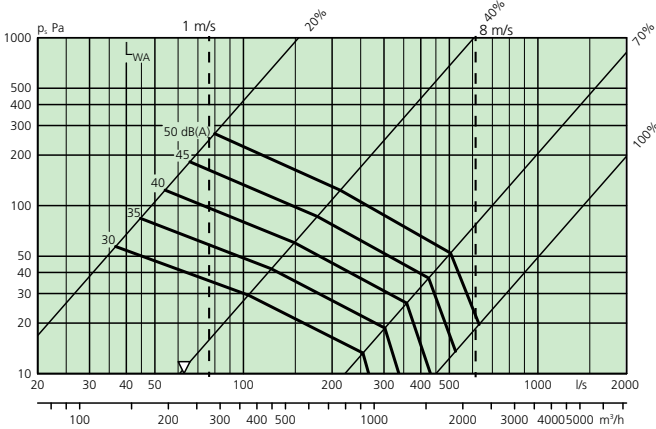

REACT V 630

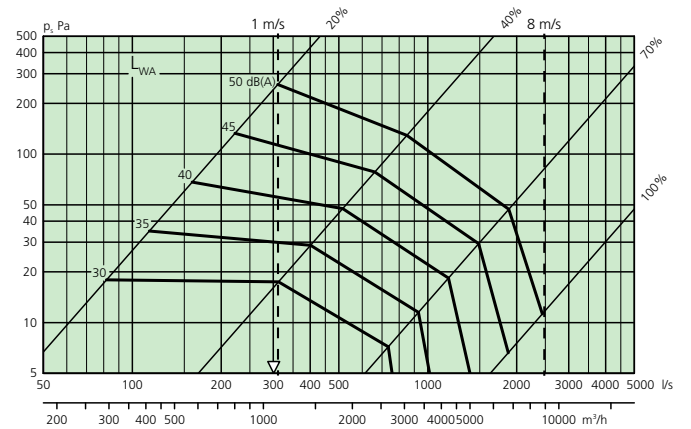

Acoustic data – rectangular design

Sound power level

- The diagram shows the A-weighted sound power (L_{WA} -dB), as a function of the air flow and pressure drop across the damper.
- Correct L_{WA} with correction factor K_{ok} from the tables below to obtain the sound power levels for each octave band ($L_W = L_{WA} + K_k + K_{ok}$).

Sound power in octave bands

$$L_W = L_{WA} + K_k + K_{ok}$$

Correction factor, K_{ok}

Size	Mid-frequency (octave band) Hz							
	63	125	250	500	1000	2000	4000	8000
All	7	3	1	0	-5	-14	-23	-22
Tol. ±	4	4	3	2	2	2	2	2

Correction factor K_k for the damper's face area

Correction factor – face area								
Area m ²	0.1	0.15	0,25	0.4	0.6	1.0	1.6	2.5
K_k	-3	-2	0	2	4	6	8	10

Sizing diagram – rectangular design

Velocity - Pressure drop - Sound level

- The data is for the sound created in ducts.
- Specified sound levels, L_{WA} : 40, 50, 60 and 70 dB.
- Calculate the face velocity across the damper and read the sound data and pressure drop at an appropriate damper position.
- 100% corresponds to the damper being fully open.

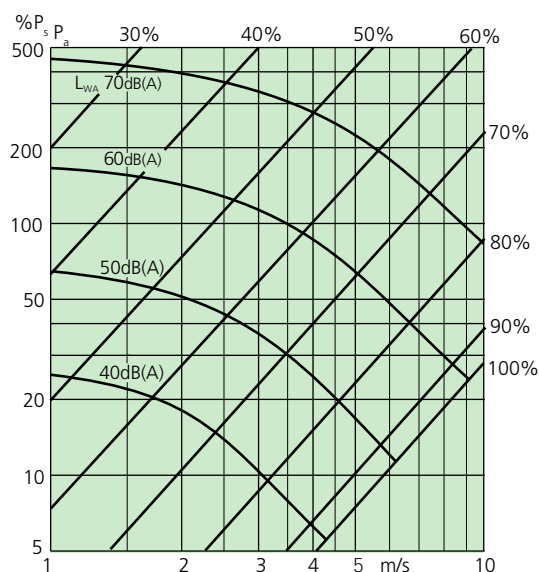

Installation, torque, dimensions and weights

Circular design

Size ØD (mm)	A (mm)	B (mm)	C (mm)	E (mm)	Normal motor		Spring return		Flow range			Tolerance Q* ±5% with at least ±x l/s	
					Torque (Nm)	Weight (kg)	Torque (Nm)	Weight (kg)	Min.		Max=Vnom ^{*)}		
									l/s	m ³ /h	l/s		m ³ /h
100	475	485	190	50	5	1.6	5	2.7	5	18	67	241	2
125	475	485	215	50	5	1.8	5	2.9	9	32	108	389	2
160	475	485	255	50	5	2.1	5	3.1	16	58	184	662	2
200	475	485	300	50	5	2.7	5	3.7	25	90	292	1051	3
250	525	535	350	50	5	3.4	5	4.5	40	144	470	1692	5
315	560	570	415	50	10	4.5	10	6.0	63	227	747	2689	8
400	695	705	505	60	10	6.5	10	8.0	102	367	1240	4464	13
500	820	840	605	60	10	9.1	10	10.6	164	590	1900	6840	20
630	915	935	735	60	15	14.0	20	15.5	300	1080	2950	10620	32

^{*)} Vnom at 120 Pa in pressure reading.

*Installed according to the instructions

Installation – all designs

- The product's air flow measurement requires a straight duct section as per the installation figures.
- In unfavourable conditions before or with disruption, the product's tolerances cannot be guaranteed.
- Instructions for Use are supplied with the product on delivery, but can also be downloaded from www.swegon.com.

Installation – circular version

- Installation is position dependent.
- Can be installed horizontally or vertically.

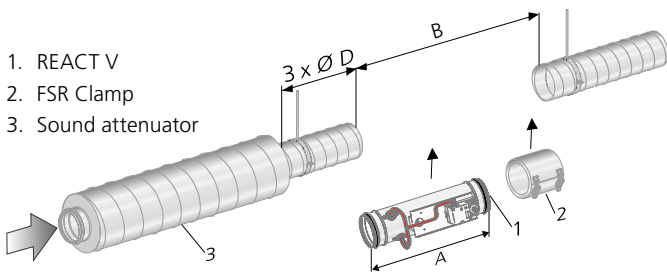

Figure 5. Requires a straight duct section of 3 x Ø for sound attenuators with baffle or centre body.

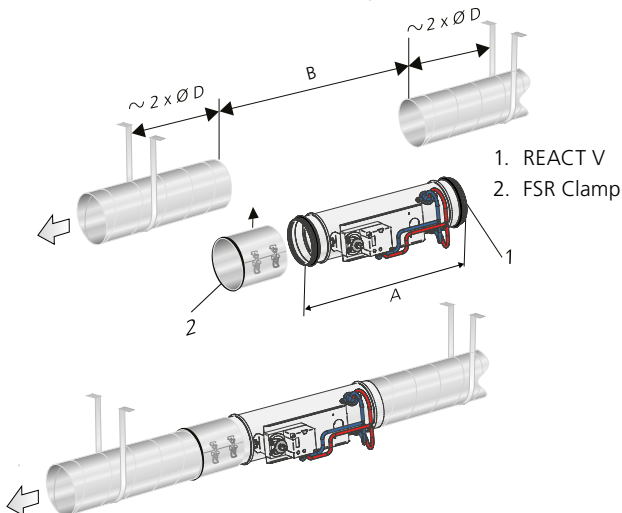

Figure 6. Installation in the duct system. The ducts must be firmly fixed to the frame of the building on each side of REACT V.

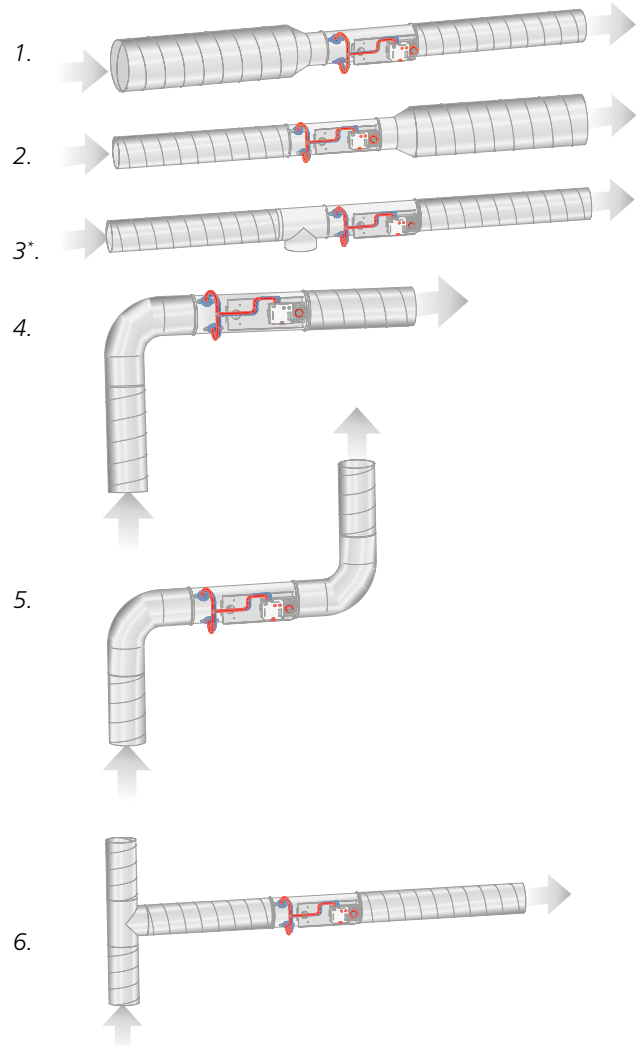

Figure 7. Straight duct section requirements, circular ducts, quantity Ø before the product: Figures 1-5 require no straight duct section (figure 3* illustrates the T piece with cleaning hatch). Figure 6 requires a straight duct section before the damper equivalent to 4 x the diameter of the duct.

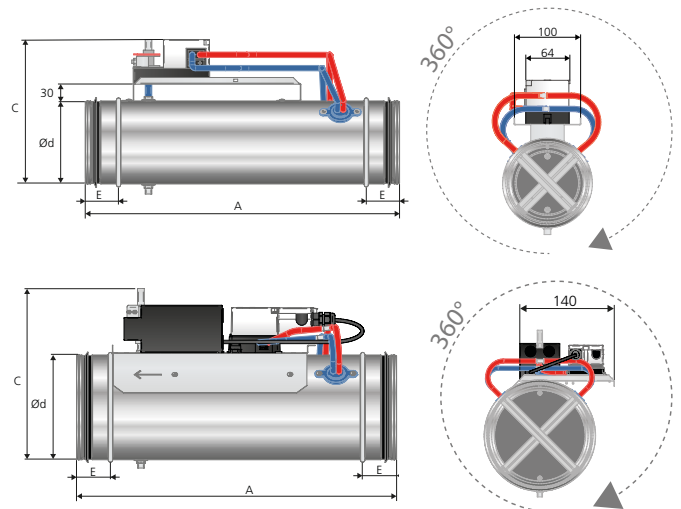

Figure 8. Dimensions (mm), REACT V circular and REACT V circular with spring return. The damper can be installed at an optional angle.

Rectangular design

Size WxH (mm)	Normal motor		Spring return		Flow range				Tolerance Q* ±5% with at least ±x l/s
	Torque (Nm)	Weight (kg)	Torque (Nm)	Weight (kg)	Min.		Max=Vnom ¹⁾		
					l/s	m³/h	l/s	m³/h	
200 x 200	5	7.2	5	8.0	67	240	365	1314	8
300 x 200	5	8.4	5	9.2	100	360	548	1971	12
400 x 200	5	9.9	5	10.7	133	480	730	2628	17
500 x 200	5	11.4	5	12.2	167	600	913	3285	21
600 x 200	5	12.9	5	13.7	200	720	1095	3942	25
700 x 200	5	14.4	5	15.2	233	840	1278	4599	29
800 x 200	5	15.4	5	16.2	267	960	1460	5256	33
1000 x 200	10	18.4	10	19.9	333	1200	1825	6570	42
300 x 300	5	10.9	5	11.3	152	548	834	3003	19
400 x 300	5	12.4	5	12.9	203	731	1112	4004	25
500 x 300	5	13.9	5	14.4	254	914	1390	5004	32
600 x 300	5	15.4	5	15.9	305	1096	1668	6005	38
700 x 300	10	16.8	10	17.8	355	1279	1946	7006	44
800 x 300	10	18.4	10	19.4	406	1462	2224	8007	51
1000 x 300	10	21.4	10	22.4	508	1827	2780	10009	63
400 x 400	5	14.0	5	14.5	273	983	1495	5382	34
500 x 400	10	16.0	10	18.0	341	1228	1869	6728	43
600 x 400	10	17.4	10	18.5	409	1474	2243	8073	51
700 x 400	10	19.6	10	20.6	478	1720	2616	9419	60
800 x 400	10	21.1	10	22.2	546	1965	2990	10764	68
1000 x 400	10	24.2	10	25.2	682	2457	3738	13456	85
1200 x 400	15	27.2	20	29.2	819	2948	4485	16147	102
1400 x 400	15	30.3	20	32.2	955	3439	5233	18838	119
1600 x 400	15	33.3	20	35.3	1092	3931	5980	21529	136
500 x 500	10	18.5	10	19.5	429	1543	2347	8449	54
600 x 500	10	20.5	10	21.6	514	1851	2816	10139	64
700 x 500	10	22.6	10	23.6	600	2160	3286	11829	75
800 x 500	10	24.6	10	25.6	686	2468	3755	13519	86
1000 x 500	15	28.6	20	30.6	857	3085	4694	16898	107
1200 x 500	15	32.7	20	34.6	1028	3702	5633	20278	129
1400 x 500	15	36.8	20	38.7	1200	4319	6572	23658	150
1600 x 500	15	40.8	20	42.8	1371	4936	7510	27037	171
600 x 600	10	22.7	10	23.7	618	2227	3388	12195	77
700 x 600	10	24.8	10	25.8	722	2598	3952	14228	90
800 x 600	15	26.8	20	27.8	825	2969	4517	16260	103
1000 x 600	15	30.9	20	32.9	1031	3711	5646	20325	129
1200 x 600	15	35.0	20	37.0	1237	4453	6775	24390	155
1400 x 600	15	39.2	20	41.1	1443	5195	7904	28455	180
1600 x 600	15	43.3	20	45.2	1649	5937	9033	32521	206
700 x 700	15	27.6	20	29.5	844	3038	4622	16638	105
800 x 700	15	30.3	20	32.2	964	3472	5282	19014	121
1000 x 700	15	34.9	20	36.8	1205	4339	6602	23768	151
1200 x 700	15	40.6	20	42.6	1446	5207	7923	28522	181
1400 x 700	15	45.7	20	47.7	1688	6075	9243	33275	211

¹⁾ Vnom at 120 Pa in pressure reading.
 *Installed according to the instructions

Installation – rectangular design

Dimension B in the figure and table below is found in the table “Rectangular design” to the left.

NOTE! Damper spindles must be installed horizontally.

Straight duct section before REACT V in rectangular ducts

Type of disruption	E (m ₂ =5%)	E (m ₂ =10%)
One 90° bend	E = 3 x B	E = 2 x B
T piece	E = 3 x B	E = 2 x B

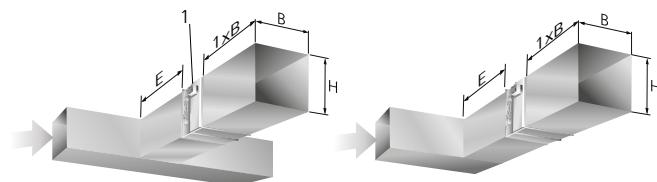

- 1. Controller/Actuator always on the side of the rectangular damper.
- E = Straight section.
- W = Width, duct.
- H = Height, duct.

Figure 9. Straight section requirements, rectangular ducts.

Straight duct section before/after REACT V – sound attenuator with baffle

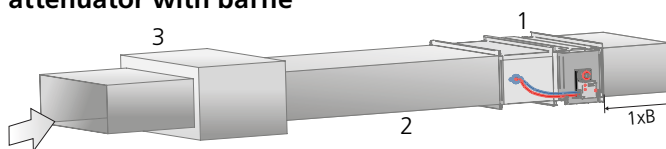

- 1. = Rectangular REACT V
- 2. = Straight duct ≥3xB.
- 3. = Sound attenuator with baffle.

Figure 10. Straight duct section requirements, rectangular REACT V and sound attenuator with baffle. Installation with a straight duct section applies to both the supply air and the extract air.

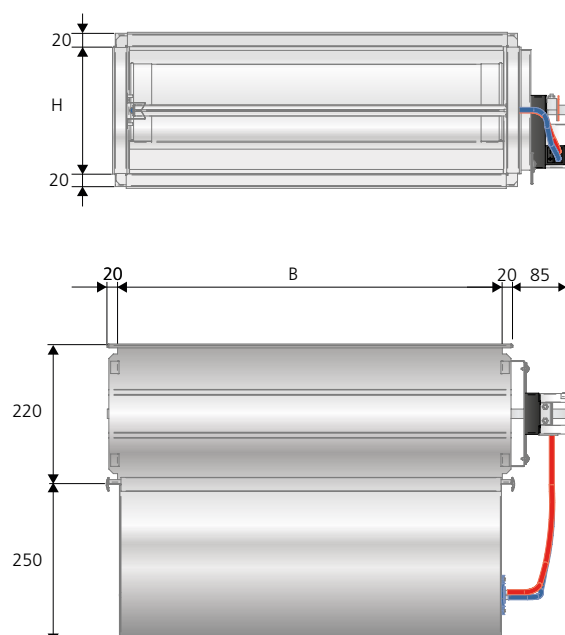

Figure 11. Dimensions (mm), REACT V rectangular, REACT V rectangular with spring return.

Specification

Product

Circular design

Circular variable flow damper REACT V a bbb -cc

Version:

Size:

100, 125, 160, 200, 250, 315, 400, 500, 630

No code = Normal design

SR = Spring return actuator, (On request specify NO/NC)

REACT V factory setting - Vmax = Vnom l/s and Vmin = 0 l/s

NO = Normally open

NC = Normally closed

Rectangular design

Rectangular variable flow damper REACT V a bbb-ccc -dd

Version:

Size:

Dimension: W x H (see table on page 9)

No code = Normal design

SR = Spring return actuator, (On request specify NO/NC)

REACT V factory setting - Vmax = Vnom l/s and Vmin = 0 l/s

NO = Normally open

NC = Normally closed

Accessories

Clamp for circular ventilation ducts FSR c aaa

Version:

Dimension: 100, 125, 160, 200, 250, 315, 400, 500, 630

Cover panel for visible installation REACT V COVER Ø

For normally circular design, all sizes

LUNA RC Room controller for temperature regulation

LUNA RE Room controller for temperature regulation

DETECT IAQ Room controller for CO₂ and temperature

DETECT IAQ OCS Room controller for CO₂ and temperature, with PIR

DETECT IAQ D Duct controller for CO₂ and temperature

DETECT O V110 Occupancy detector for wall and corner installation

DETECT O T360 Occupancy detector for ceiling installation

Specification text

Example of a specification text according to VVS AMA.

QJB.11 Circular rotary damper with single blade

Make: Swegon

Type: REACT V

Variable flow damper with the following functions:

- Pressure-independent VAV unit for demand-controlled ventilation
- Integrated flow measurement
- Integrated controller, flow regulating
- The damper can be ordered with factory-fitted spring return actuator
- The damper can be ordered with factory-fitted external insulation

Must be installed with a minimum straight duct section on the inlet side as per the product sheet.

Size: Ø 100 to Ø 630

Specification

Standard SS-EN 1751: 2014, Annex C
 Power supply: 24 V AC ±15% 50 - 60 Hz
 Air tightness class, casing: C
 Air tightness class closed damper: 4
 Corrosivity class: C3
 Pressure class: A
 Tolerance flow measurement: ±5%, however, at least ±X l/s according to the table in the product sheet

Type: REACT Va bbb-cc xx pcs

Accessories

Clamp for ventilation ducts FSR xx items
 Cover panel for visible installation REACT V COVER Ø

QJB.41 Louvre damper with counter-rotating blade

Make: Swegon

Type: REACT V

Variable flow damper with the following functions:

- Pressure-independent VAV unit for demand-controlled ventilation
- Integrated flow measurement
- Integrated controller, flow regulating
- The damper can be ordered with factory-fitted spring return actuator

Must be installed with a minimum straight duct section on the inlet side as per the product sheet.

Size: 200 x 200 to 1400 x 700

Specification

Standard SS-EN 1751: 2014, Annex C
 Power supply: 24 V AC ±15% 50 - 60 Hz
 Air tightness class, casing: C
 Air tightness class closed damper: 3
 Corrosivity class: C3
 Pressure class: A
 Tolerance flow measurement: ±5%, however, at least ±X l/s according to the table in the product sheet

Type: REACT Va bbb-ccc-dd xx pcs