

# COLIBRI Ceiling VF

Square ceiling diffuser with nozzles for supply air with variable flow



## QUICK FACTS

- Circular nozzle pattern
- Suitable for VAV and DCV applications
- Manages large temperatures below room temperature (High  $\Delta T$ )
- Fast and easy installation and commissioning through Swegon Quick Access
- 100% flexible distribution pattern
- Designed for modular suspended ceiling
- Used together with the REACT ALS commissioning box for variable flow regulation
- Commissioning box ALS with one- or two-dimensional changes between duct and air diffuser connection
- ADAPTER for suspended ceiling system
- Standard colour White RAL 9003
  - 5 alternative standard colours
  - Other colours upon request

AIR FLOW - SOUND PRESSURE ROOM (Lp10A) <sup>*)</sup>									
COLIBRI Ceiling VF Size			25 dB(A)		30 dB(A)		35 dB(A)		
			l/s	m <sup>3</sup> /h	l/s	m <sup>3</sup> /h	l/s	m <sup>3</sup> /h	
250-600			73	263	86	310	101	364	
315-600			93	335	109	392	127	457	
COLIBRI Ceiling VF Size	REACT ALS Size	Min.*	25 dB(A)		30 dB(A)		35 dB(A)		
		l/s	m <sup>3</sup> /h	l/s	m <sup>3</sup> /h	l/s	m <sup>3</sup> /h	l/s	m <sup>3</sup> /h
250-600	160-250	7	25	62	223	74	263	87	313
315-600	250-315	20	72	93	335	108	392	127	457
COLIBRI Ceiling VF Size	ALS Size	25 dB(A)		30 dB(A)		35 dB(A)			
		l/s	m <sup>3</sup> /h	l/s	m <sup>3</sup> /h	l/s	m <sup>3</sup> /h	l/s	m <sup>3</sup> /h
250-600	160-250	62	223	73	263	87	313		
250-600	200-250	66	238	78	281	91	328		
315-600	200-315	84	302	98	353	115	414		
315-600	250-315	89	320	103	371	119	428		

Data is specified for supply air with an open damper when a REACT ALS or ALS commissioning box is used.

<sup>\*)</sup> Lp10A = Sound pressure incl. A-filter with 4 dB room attenuation and 10 m<sup>2</sup> room absorption area.

\*The product must not go below min. as the measurement function cannot then be guaranteed. For tolerances, see page 12. NOTE: for a high pressure drop across the product, it may be difficult to reach the min. flow. See the sizing diagrams.

# Contents

<b>Technical description .....</b>	<b>3</b>
Design .....	3
Material and surface treatment .....	3
Accessories .....	3
Planning .....	3
Installation .....	3
Commissioning with ALS .....	4
Maintenance.....	4
Environment .....	4
Installation.....	5
<b>Sizing .....</b>	<b>6</b>
Sound data – Air diffuser only.....	6
Sound data – Air diffuser with REACT ALS.....	6
Sound data – Air diffuser with ALS .....	6
Sizing diagram .....	7
COLIBRI Ceiling VF with REACT ALS – Supply air .....	7
COLIBRI Ceiling VF with ALS – Supply air.....	8
<b>Dimensions and weights.....</b>	<b>9</b>
Nozzle pattern and nozzle settings.....	10
<b>Specification.....</b>	<b>11</b>
<b>Specification text.....</b>	<b>12</b>

# Technical description

## Design

- The square supply air diffuser COLIBRI Ceiling VF comprises a backing box and a diffuser face with rotatable nozzles in a circular pattern.
- The diffuser face is hung on hinges on one side and secured by springs on the opposite side.
- Quick Access gives simpler and faster handling during installation, commissioning and cleaning, see Figure 1.

## Material and surface treatment

The backing box and diffuser face are made of sheet steel. The sleeve coupling is made of galvanised sheet steel. The interior and exterior of the air diffuser is painted.

- Standard colour:
    - White semi-gloss, lustre 40, RAL 9003/NCS S 0500-N
  - Alternative standard colours:
    - Silver gloss, lustre 80, RAL 9006
    - Grey aluminium gloss, lustre 80, RAL 9007
    - White semi-gloss, lustre 40, RAL 9010
    - Black semi-gloss, lustre 35, RAL 9005
    - Grey semi-gloss, lustre 30, RAL 7037
  - Non-painted finish and other colours available on request.
- The nozzles are made of plastic (PP-polypropylene).

## Accessories

### Commissioning boxes

#### REACT ALS/ALS

- The commissioning box is made of galvanized sheet steel.
- Removable commissioning damper, fixed measurement tappings.
- Sound-absorbing material\*) with reinforced surface layer.
- Tightness class C on the housing according to SS-EN 12237.
- The commissioning box ALS is available with 1 or 2 changes in dimension between the inlet and outlet.

\*) Fire resistance rated to B-s1,d0 in accordance with EN ISO 11925-2

### Frame

#### SAR K

- For aesthetic installation of a lowered diffuser face.

### Adapter

#### ADAPTER

For adaptation to various variants and makes of systemised false ceilings: Ecophon, Gyproc, Dampa, etc. Also used for adaptation to optional sizes of lay-in ceilings, for instance 625 x 625 or 675 x 675. Specification can be found in the product sheet for ADAPTER.

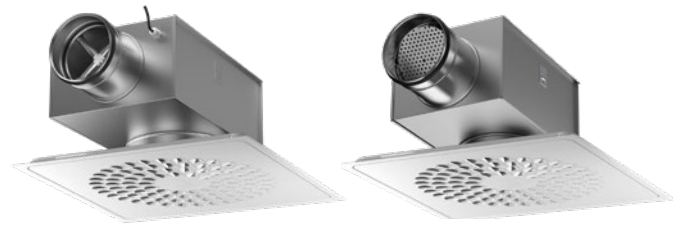

COLIBRI Ceiling VF with REACT ALS    COLIBRI Ceiling VF with ALS

## Planning

- COLIBRI Ceiling VF has the dimensions 595 x 595 mm in all connection sizes.
- The air diffuser is easy to install in modular suspended ceilings with modular dimensions of 600 x 600 mm.

## Installation

- To dismantle the diffuser face, insert a thin object, for example a Quick Access card, in between the diffuser face and the backing box in order to release the springs. Slide the card from the centre out towards the corners, see Figure 1.
- The inlet spigot of the backing box can be secured to the connecting duct by means of screws or blind rivets.
- For flush-mounting in fixed suspended ceilings, the air diffuser is secured to the building structure by means of screws through either the sides or top of the backing box.
- Secure the air diffuser in the correct position with screws or blind rivets in the underside of the commissioning box.
- For mounting in modular suspended ceilings, it is advisable to select air diffusers with outer dimensions of 595 x 595 mm. Position these directly in the T-bar framework, and then secure them to the duct system or to the commissioning box.
- When a REACT ALS or ALS commissioning box is used, it must be secured to the building structure by means of hangers or mounting brackets.
- The distance between the commissioning box and the air diffuser can be increased up to 500 mm with a circular duct, without having to lengthen the measuring tubes and damper adjustment cords. See figure 2.

## Commissioning with ALS

- Commissioning should be carried out with the diffuser face mounted.
- The measuring tubes and damper adjustment cords are pulled out through the diffuser face.
- Connect a pressure gauge to the measuring tube/tubes.
- The red and the blue tubes respectively from the ALS commissioning box of the one or two-step version are used for supply air.
- The rated coefficient of performance of the air diffuser can be used in a calculation to determine the required commissioning pressure.
- The adjusted damper position is saved by tying together the damper cord in an adjustment knot.
- Measurement accuracy and straight section requirement before the commissioning box. See Figure 2.
- Length of straight section of duct depends on type of obstruction upstream of the commissioning box.
- Figure 2 shows a bend, a change in dimension and T-piece.
- Other types of disturbances require at least 2xD straight section (D = connection dimension) to obtain a measurement accuracy of  $\pm 10\%$  on the flow.
- The K-factor is specified on the product's identification label, as well as in the relevant commissioning instructions at [www.swegon.com](http://www.swegon.com).

## Maintenance

- The air diffuser can be cleaned, if necessary, using lukewarm water with dishwashing detergent.
- Alternatively a vacuum cleaner and brush nozzle is used.
- The duct system can be reached for cleaning by opening the diffuser face. If a REACT ALS or ALS commissioning box is used, pull the distributor plate aside and then grip and twist the damper unit from of its mounting.

## Environment

The Building Materials Declaration can be downloaded from [www.swegon.com](http://www.swegon.com).

Installation

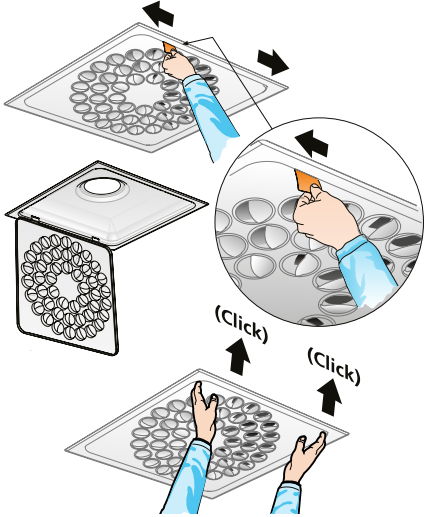

Figure 1. Quick Access, dismantling the diffuser face.

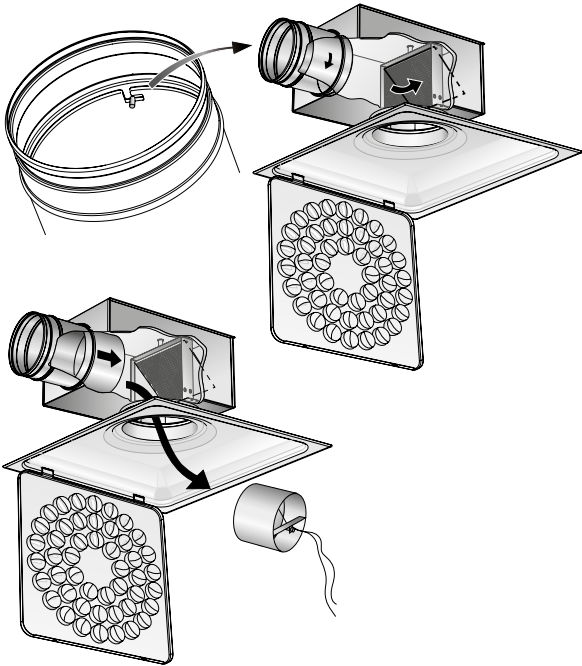

Figure 3. Dismantling the damper when using REACT ALS and ALS commissioning box.

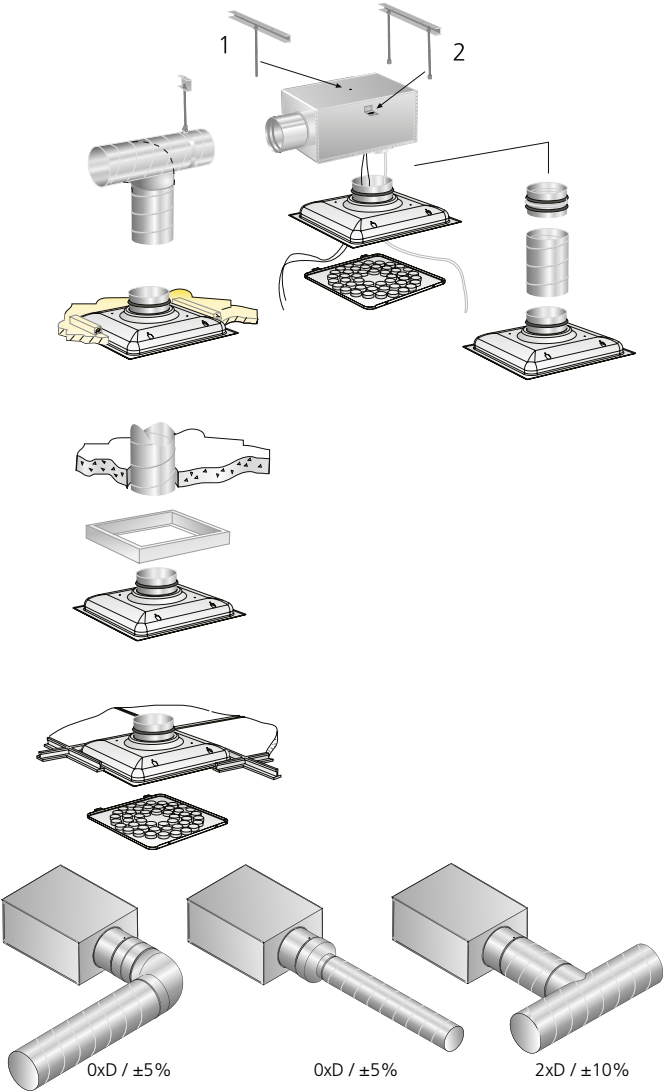

Figure 2. Installation options for the ALS commissioning box. See the REACT ALS product sheet for installation options with active commissioning box.

## Sizing

- Sound pressure level dB(A) applies to rooms with an equivalent sound absorption area of 10 m<sup>2</sup>.
- Sound attenuation (ΔL) below is shown in the octave band. Orifice attenuation is included in the values.
- The throw length  $l_{0,2}$  is measured under isothermal discharge conditions.
- The recommended max. permissible temperature below room temperature is 14 K.

- To calculate the air stream diffusion, air velocities in the occupied zone or sound levels in rooms with other dimensions, please refer to our calculation software available on [www.swegon.com](http://www.swegon.com).

$L_w$  = Sound power level

$L_{p10A}$  = Sound pressure level dB (A)

$K_{ok}$  = Correction for producing the  $L_w$  values in the octave band

$L_w = L_{p10A} + K_{ok}$  gives the frequency divided octave band

## Sound data – Air diffuser only

### COLIBRI Ceiling VF – Supply air

#### Sound power level $L_w$ (dB)

Table  $K_{ok}$

Size	Mid-frequency (octave band) Hz							
	63	125	250	500	1000	2000	4000	8000
250-600	-5	-1	1	4	0	-11	-26	-28
315-600	0	0	-1	2	2	-11	-27	-29
Tol. ±	2	2	2	2	2	2	2	2

#### Sound attenuation ΔL (dB)

Table ΔL

Size	Mid-frequency (octave band) Hz							
	63	125	250	500	1000	2000	4000	8000
250-600	16	11	5	4	2	3	4	4
315-600	14	9	4	2	2	2	3	3
Tol. ±	2	2	2	2	2	2	2	2

## Sound data – Air diffuser with REACT ALS active commissioning box

### COLIBRI Ceiling VF + REACT ALS – Supply air

#### Sound power level $L_w$ (dB)

Table  $K_{ok}$

Size	Mid-frequency (octave band) Hz							
	63	125	250	500	1000	2000	4000	8000
160-250	-2	2	-3	-7	-9	-11	-12	-5
250-350	-2	2	-3	-6	-6	-9	-12	-7
Tol. ±	2	2	2	2	2	2	2	2

#### Sound attenuation ΔL (dB)

Table ΔL

Size	Mid-frequency (octave band) Hz							
	63	125	250	500	1000	2000	4000	8000
160-250	15	9	9	20	19	15	16	14
250-350	13	8	10	19	16	13	16	16
Tol. ±	2	2	2	2	2	2	2	2

## Sound data – Air diffuser with ALS commissioning box

### COLIBRI Ceiling VF + ALS – Supply air, one step

#### Sound power level $L_w$ (dB)

Table  $K_{ok}$

Size	Mid-frequency (octave band) Hz							
	63	125	250	500	1000	2000	4000	8000
200-600	-3	6	3	3	-1	-9	-18	-23
250-600	-3	5	2	2	1	-10	-22	-26
Tol. ±	2	2	2	2	2	2	2	2

#### Sound attenuation ΔL (dB)

Table ΔL

Size	Mid-frequency (octave band) Hz							
	63	125	250	500	1000	2000	4000	8000
200-600	13	8	8	16	17	12	12	13
250-600	11	6	7	19	14	10	10	13
Tol. ±	2	2	2	2	2	2	2	2

### COLIBRI Ceiling VF + ALS – Supply air, two steps

#### Sound power level $L_w$ (dB)

Table  $K_{ok}$

Size	Mid-frequency (octave band) Hz							
	63	125	250	500	1000	2000	4000	8000
160-600	0	7	5	2	-3	-8	-16	-20
200-600	-3	7	5	1	-1	-9	-19	-21
Tol. ±	2	2	2	2	2	2	2	2

#### Sound attenuation ΔL (dB)

Table ΔL

Size	Mid-frequency (octave band) Hz							
	63	125	250	500	1000	2000	4000	8000
160-600	15	9	9	20	19	15	16	14
200-600	13	8	10	19	16	13	16	16
Tol. ±	2	2	2	2	2	2	2	2

## Sizing diagram

### Air flow – Pressure drop – Sound level – Throw length

- The diagrams illustrate data for recessed air diffuser in a ceiling.
  - The diagrams should not be used for commissioning.
  - The dB(A) values apply to rooms with normal acoustic absorption, 4 dB room attenuation/10 m<sup>2</sup> equivalent room absorption area.
  - The dB(C) value is normally 6-9 dB higher than the dB(A) value.
  - The throw length  $l_{0,2}$  is measured under isothermal discharge conditions.
  - The recommended max. permissible temperature below room temperature is 14 K.
  - To calculate the air stream diffusion, air velocities in the occupied zone or sound levels in rooms with other dimensions, please refer to our calculation software available on [www.swegon.com](http://www.swegon.com)
- $\nabla$  = Min. flow required for obtaining sufficient commissioning pressure.
  - Low installation height generates about 3 dB(A) higher sound level than the value plotted in the graph.
  - Throw length based on rotation setting. For other adjustments, see the graphs for diffuser with REACT ALS or ALS commissioning box.

### COLIBRI Ceiling VF – Air diffuser only – Supply air

#### COLIBRI Ceiling VF 250-600, 315-600

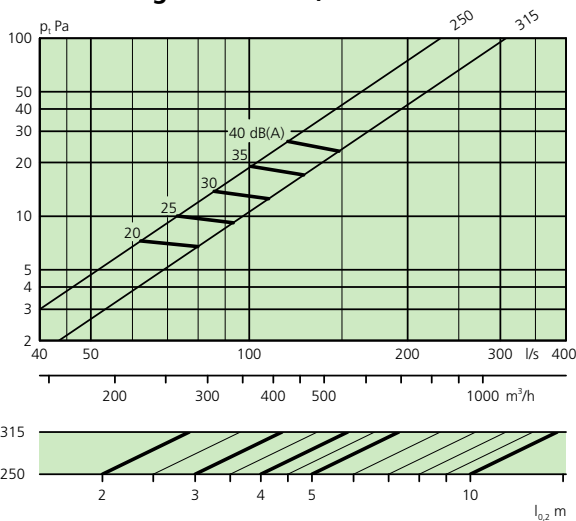

### COLIBRI Ceiling VF with REACT ALS active commissioning box – Supply air

#### COLIBRI Ceiling VF 250-600 + REACT ALS 160-250

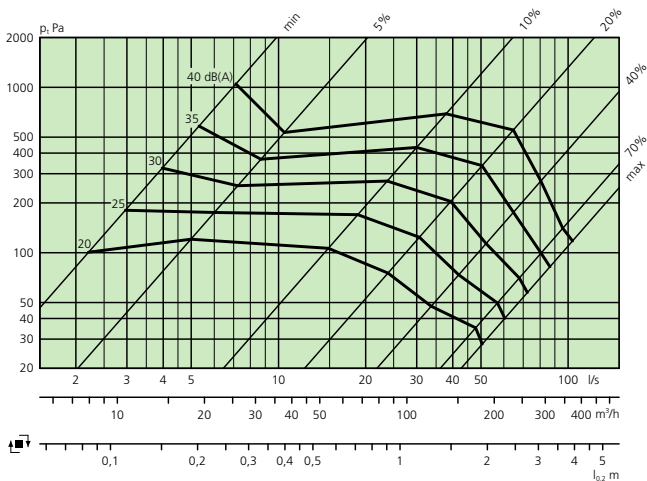

#### COLIBRI Ceiling VF 315-600 + REACT ALS 250-315

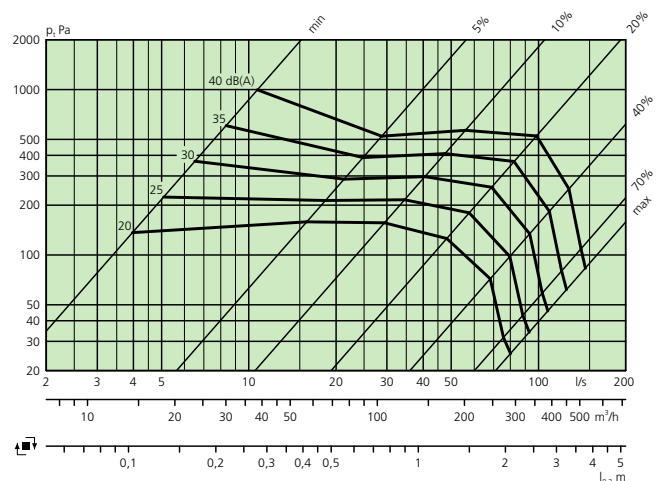

COLIBRI Ceiling VF with ALS commissioning box – Supply air

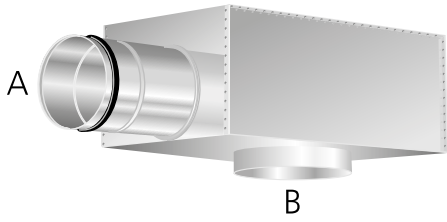

Correlation, connection dimensions.

A = duct connection, B = air diffuser connection.

Explanation of step model:

- One step = A dimensional change between A and B, e.g. A = Ø160 mm and B = Ø200 mm.
- Two steps = Two-dimensional changes between A and B, e.g. A = Ø160 mm and B = Ø250 mm.

COLIBRI Ceiling VF 250-600 + ALS 160-250

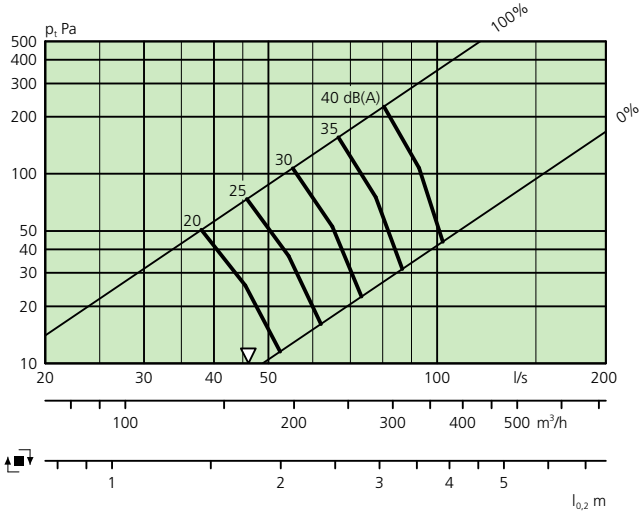

COLIBRI Ceiling VF 250-600 + ALS 200-250

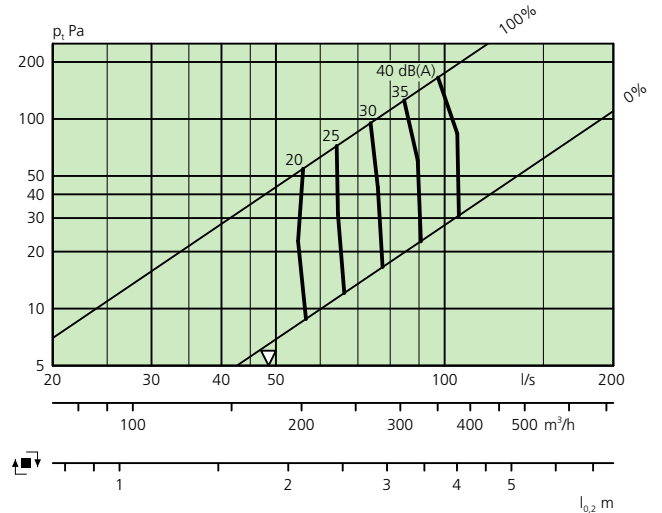

COLIBRI Ceiling VF 315-600 + ALS 200-315

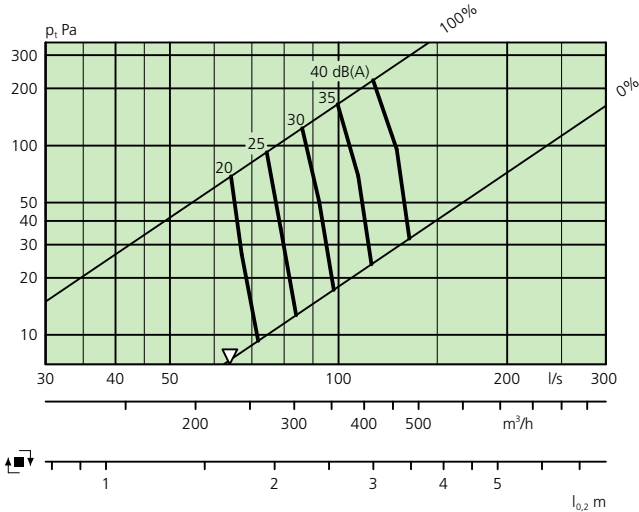

COLIBRI Ceiling VF 315-600 + ALS 250-315

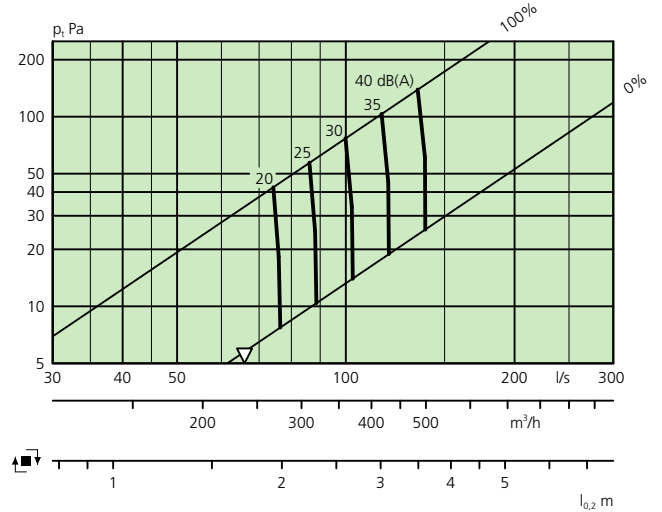



# Dimensions and weights

## COLIBRI Ceiling VF

Size	Dimensions (mm)				Weight (kg)	Number of nozzles
	A	Ød1	I	M		
250-600	595	249	575	70	3.5	90
315-600	595	314	575	50	3.5	130

Dimensions of opening in ceiling l x l

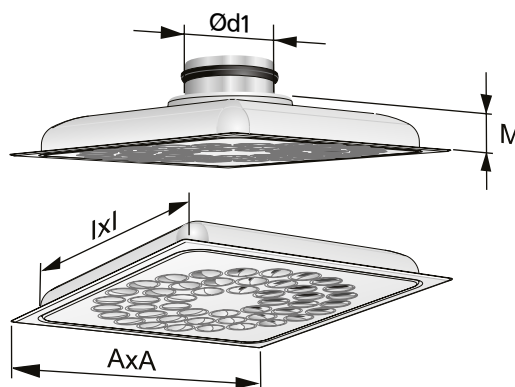

Figure 4. COLIBRI Ceiling VF.

## COLIBRI Ceiling VF with REACT ALS active commissioning box

Size	Dimensions (mm)											Weight (kg)
	A	B	C	ØD	Ød	E1	F1	G1	H	K	Q	
250-600	595	504	332	159	250	314	113	214	450	100	40	8.4
315-600	595	622	388	249	315	395	95	247	575	140	40	11.3

## COLIBRI Ceiling VF with ALS commissioning box – One step

Size	Dimensions (mm)											Weight (kg)
	A	B	C	ØD	Ød	E1	F1	G1	H	K	Q	
250-600	595	504	332	199	250	354	113	225	465	115	40	8.7
315-600	595	622	388	249	315	395	93	230	575	140	40	11.8

## COLIBRI Ceiling VF with ALS commissioning box – Two steps

Size	Dimensions (mm)											Weight (kg)
	A	B	C	ØD	Ød	E1	F1	G1	H	K	Q	
250-600	595	504	332	159	250	314	113	205	450	100	40	7.0
315-600	595	622	388	200	315	334	93	205	550	100	40	8.7

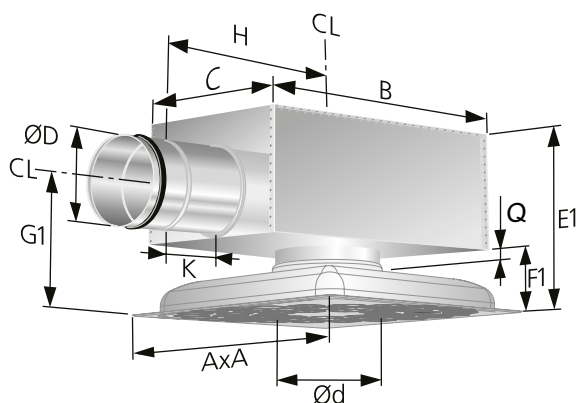

Figure 5. COLIBRI Ceiling VF with REACT ALS or ALS commissioning box.  
CL = Centreline.

## Frame - SAR K

Size	L	Weight (kg)
600	595	1.0

When installing size 315-600 diffusers, position the ALS box so that its branch extends 20 mm below the ceiling surface

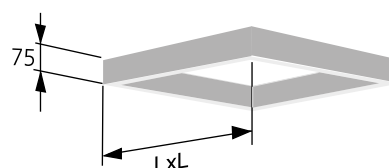
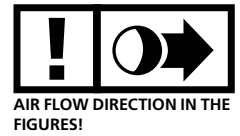

Figure 6. Frame, SAR K.

## Nozzle pattern and nozzle settings

Standard and optional nozzle settings for various air distribution patterns. Note the air flow direction in the figures.



### Example, nozzle pattern:

**Clock-wise swirl  
(standard)**

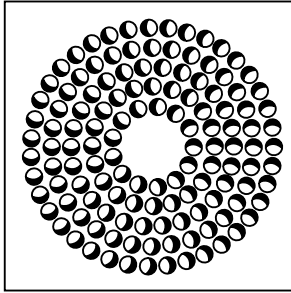

**1-way**

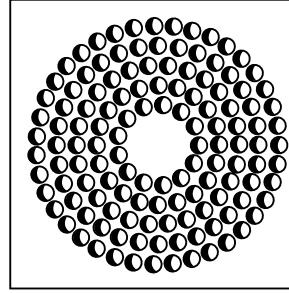

**2-way**

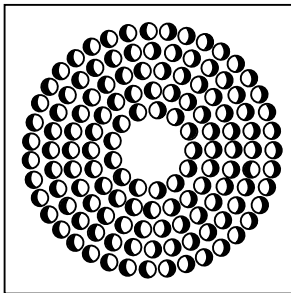

**3-way**

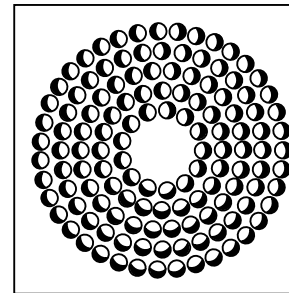

**4-way**

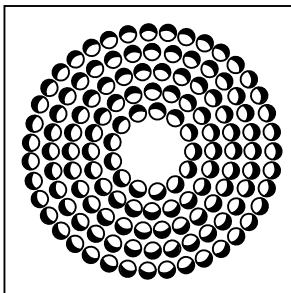

**Counter-flow distribution pattern**

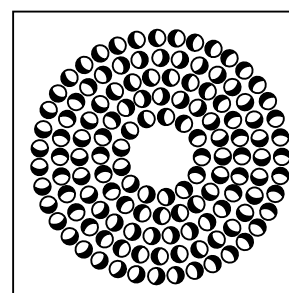

**VD Vertical, diffused**

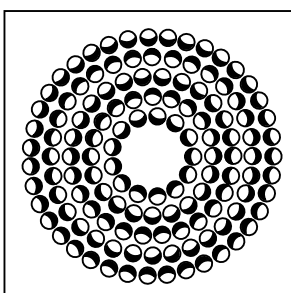

**VK Vertical, concentrated**

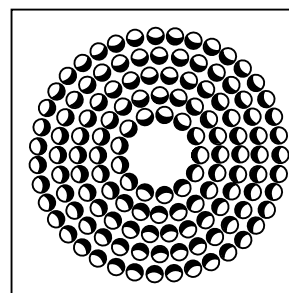

# Specification

## Product

Square ceiling diffuser for COLIBRI CC VF a aaa -bbb  
supply air with variable flow

Version:

Nom. connection dimension, mm:  
250, 315

Nom. square dimension, mm: 600

Size – Standard range: 250-600  
315-600

## Accessories

Commissioning box with REACT ALS a aaa-bbb  
variable flow regulation

Version:

For COLIBRI Ceiling VF	REACT ALS
250-600	160-250
315-600	250-315

Commissioning box ALS d aaa-bbb

Version:

For COLIBRI Ceiling VF	ALS
250-600	160-250 and 200-250
315-600	200-315 and 250-315

Frame SAR b K aaa

Version

Square = K

For size:	250-600	600
	315-600	600

ADAPTER for modular suspended ceiling ADAPTER  
See specification in separate product sheet

# Specification text

## Air diffuser with REACT ALS active commissioning box

Make: Swegon

Type: COLIBRI Ceiling VF + REACT ALS

Swegon's complete square ceiling diffuser type COLIBRI Ceiling VF with circular nozzle pattern and REACT ALS commissioning box including the following functions:

- Pressure-independent VAV unit for demand-controlled ventilation.
- Integrated flow measurement.
- Integrated controller, flow regulating.
- Setting and reading of parameters on controller.

Must be installed with a minimum straight duct section on the inlet side as per the product sheet for REACT ALS.

Size: Ø160  
Ø250

**Specification** COLIBRI Ceiling VF  
Corrosivity class: C2 (Powder paint Epoxy Polyester)

**Specification** REACT ALS  
Standard SS-EN 1751: 2014, Annex C  
Power supply: 24 V AC ±15% 50 - 60Hz  
Air tightness class, casing: C  
Corrosivity class: C3  
Tolerance flow measurement: ±5%, however, at least ±X l/s according to the table in the product sheet for REACT ALS

Size: COLIBRI CC VFa aaa-bbb with REACT ALSa aaa-bbb xx pcs

**Accessories**  
Frame: SARb K aaa xx pcs

## Air diffuser with ALS commissioning box

Make: Swegon

Type: COLIBRI Ceiling VF + ALS

Swegon's complete square ceiling diffuser type COLIBRI Ceiling VF with circular nozzle pattern and ALS commissioning box including the following functions:

- Designed for modular suspended ceilings (600x600 mm).
- 100% flexible distribution pattern.
- Individually adjustable nozzles.
- Quick Access for rapid access to the commissioning box and the duct system.
- Cleanable ALS commissioning box with removable commissioning damper.
  - Method of measurement with low systematic error.
  - Interior sound absorbing lining with reinforced surface layer.
- Powder-painted and baked white finish, RAL 9003/NCS S 0500-N.

**Specification** COLIBRI Ceiling VF  
Corrosivity class: C2 (Powder paint Epoxy Polyester)

**Specification** ALS  
Air tightness class, casing: C  
Corrosivity class: C3  
Size: COLIBRI CC VFa aaa-bbb with ALSd aaa-bbb xx pcs

**Accessories**  
Frame: SARb K aaa xx pcs